



DESMI

MARINE & OFFSHORE PUMP SOLUTIONS

PROVEN TECHNOLOGY

DESMI

DESMI Centrifugal Pumps

DESMI centrifugal pumps are used as cooling, ballast, fire, and bilge pumps for fresh as well as seawater. The pumps are available with capacities up to 7400 m³/h/32600 US gpm and delivery heads up to 200 mWC.

Our product range is based on the modular principle which gives interchangeability of the most commonly used items and consequently a quick and safe supply of spare parts.

DESMI pumps are also installed in many naval vessels where special requirements as to materials, shock resistance etc. apply.

Single pumps or complete packages, DESMI's staff will always find the correct solution. Our world-wide network of subsidiaries and distributors ensures prompt spare parts supply and first-class after-sales-service.

DESMI Centrifugal Pumps (Vertical Pumps)

DSL

Vertical In-line Double Suction Centrifugal Pump DSL	
Normal Diameter (DN)	150 to 600
Flow rate - 50 Hz	Up to 6200 m ³ /h (27300 US gpm)
Flow rate - 60 Hz	Up to 7400 m ³ /h (32600 US gpm)
Head	Up to 140 m (460 ft)
Pressure	Up to 25 bar (360 psi)
Temperature	Up to 140 °C (284 °F)
Motor	Standard and Ex motor
VFD	Bulkhead/Wall-mounted
ATEX approved.	
Applications: Ballast and cooling water pumping are among the many tasks that the DSL pumps solve to perfection. But also district heating and power plants together with many other industries will profit from using DSL pumps. Pump materials available in bronze, cast iron and stainless steel.	

DSL Benefits:

- Suction design provides a perfect flow
- High efficiency and low NPSH values



DSL

NSL

Vertical In-line Single Suction Centrifugal Pump NSL	
Normal Diameter (DN)	80 to 350
Flow rate - 50 Hz	Up to 2000 m ³ /h (8800 US gpm)
Flow rate - 60 Hz	Up to 2400 m ³ /h (10600 US gpm)
Head	Up to 195 m (640 ft)
Pressure	Up to 25 bar (360 psi)
Temperature	Up to 140 °C (284 °F)
Motor	Standard and Ex motor
VFD	Direct or Bulkhead/Wall-mounted
ATEX approved	
Applications: Various marine applications such as seawater cooling systems, LT-cooling systems, HT-cooling systems, ballast water pumps and fire pumps. Pump materials available in bronze, cast iron and stainless steel.	

NSL Benefits :

- High efficiency
- Low NPSH values
- Easy installation/service
- Various materials



NSL

NSLV / NSLH

Vertical and Horizontal end-suction Centrifugal Pump NSLV / NSLH	
Normal Diameter (DN)	65 to 600
Flow rate - 50 Hz	Up to 6200m ³ /h (27300 US gpm)
Flow rate - 60 Hz	Up to 5900m ³ /h (26000 US gpm)
Head	Up to 200 m (660 ft)
Pressure	Up to 25 bar (360 psi)
Temperature	Up to 140°C (284 °F)
Motor	Standard and Ex motor
VFD	Direct or Bulkhead/Wall-mounted
ATEX approved	
The DESMI NSLV pumps are constructed for vertical mount (with suction flange downwards) and the NSLH pump for horizontal mounting.	
Applications: The pumps are particularly suitable for the pumping of water in connection with cooling systems, cooling of diesel engines, as bilge pumps, ballast pumps, fire pumps, brine pumps, pumps for irrigation, fish farms, water works, district heating, salvage corps, army and navy, etc.	

- High efficiency
- Low NPSH values
- Easy installation/service
- Various materials and further, an attractive price.



NSLV

NSLH

DESMI Centrifugal Pumps (Vertical Pumps and horizontal)

ESL / ESLH

Vertical In-line / Horizontal end-suction Centrifugal Pump ESL / ESLH	
Norminal Diameter (DN)	25 to 100
Flow rate - 50 Hz	Up to 200 m ³ /h (880 US gpm)
Flow rate - 60 Hz	Up to 250 m ³ /h (1100 US gpm)
Head	Up to 65 m (220 ft)
Pressure	Up to 30 bar (435 psi)
Temperature	Up to 140°C (284 °F)
Motor	Standard and Ex motor
VFD	Direct or Bulkead/Wall-mounted
ATEX approved	
Applications: Various water applications such as hot water circulation, fresh water circulation, refrigeration, HVAC, hydrophore pump, cooling water. Pump materials available in bronze, cast iron and stainless steel.	

ESL Benefits :

- High efficiency
- Low NPSH values
- Compact design
- Easy installation
- Low maintenance costs



ESLHT

Horizontal end-suction Centrifugal Pump ESLHT	
Norminal Diameter (DN)	25 to 65
Flow rate - 50 Hz	Up to 100 m ³ /h (440 US gpm)
Flow rate - 60 Hz	Up to 120 m ³ /h (530 US gpm)
Head	Up to 65m (220 ft)
Pressure	Up to 30 bar (435 psi)
Temperature	Up to 180°C (356 °F)
Motor	Standard and Ex motor
VFD	Direct or Bulkead/Wall-mounted
Applications: High temperatures water circulation e.g., marine boiler water circulation, hot water supply or other heat transfer applications.	

ESLHT Benefits :

- High efficiency
- Compact design
- High temperature liquid transportation and circulation

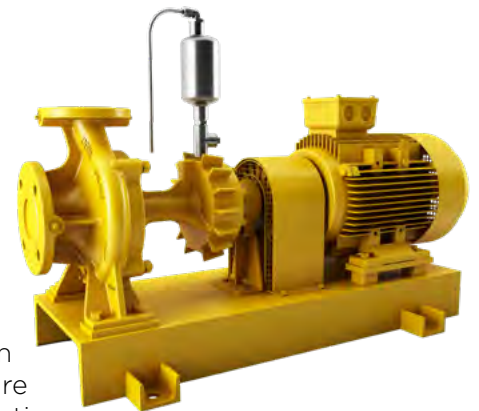

TSL & TSLH

Vertical in-line / Horizontal Two-stage Centrifugal Pump TSL & TSLH	
Norminal Diameter (DN)	40 & 50
Flow rate - 50 Hz	Up to 40 m ³ /h (180 US gpm)
Flow rate - 60 Hz	Up to 48 m ³ /h (210 US gpm)
Head	Up to 135 m (440 ft)
Pressure	Up to 16 bar (230 psi)
Temperature	Up to 140°C (284 °F)
Motor	Standard and Ex motor
VFD	Direct or Bulkead/Wall-mounted
Applications: Boiler water supply, Ballast water backflush, Sprinkler, Fire water jockey, EGCS demist cleaning, Industrial cleaning, Water treatment and filtration	

- Two-stage, single-suction-Vertical or horizontal
- High differential pressure
- Flow up to 48 m³/h

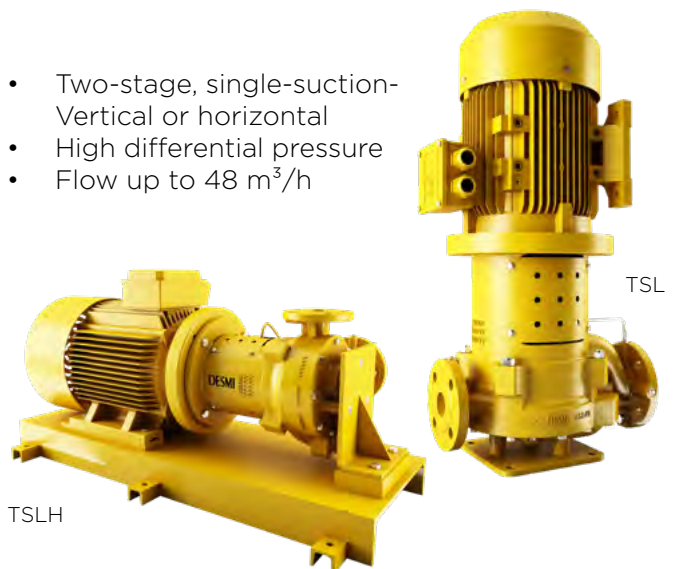

DESMI Centrifugal Pumps (Horizontal Pumps)

A DESMI speciality is horizontal, self-priming pumps where suction is based on the diffuser principle and

the pump itself is able to evacuate the suction line at suction lifts up to 8.5 m/278 ft.

Modular S

Horizontal Self-priming Centrifugal Pump Modular S	
Normal Diameter (DN)	32 - 125
Flow rate - 50 Hz	Up to 340 m ³ /h (1500 US gpm)
Flow rate - 60 Hz	Up to 410 m ³ /h (1800 US gpm)
Head	Up to 140 m (460 ft)
Pressure	Up to 16 bar (230 psi)
Temperature	Up to 140°C (284 °F)
Motor	Standard and Ex motor
VFD	Direct or Bulhead/Wall-mounted
ATEX approved	
Applications: Bilge pumps, ballast pumps, fire pump, cooling-water pumps, deck-wash pumps and general service pumps.	

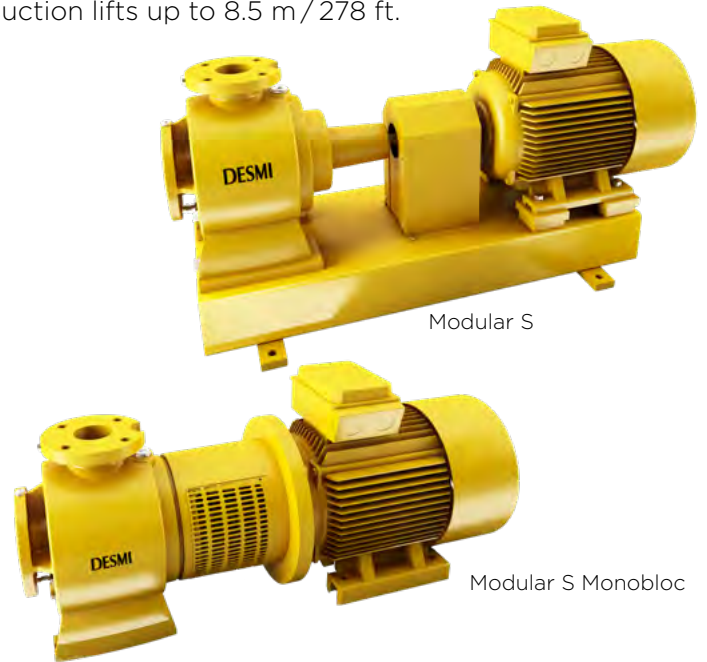

SA

Horizontal self-priming Centrifugal pump SA / SAEN	
Normal Diameter (DN)	20 to 200
Flow rate - 50 Hz	Up to 610 m ³ /h (2700 US gpm)
Flow rate - 60 Hz	Up to 730 m ³ /h (3200 US gpm)
Head	Up to 115 m (375 ft)
Pressure	Up to 12 bar (170 psi)
Temperature	Up to 140°C (284 °F)
Motor	Standard and Ex motor
VFD	Direct or Bulhead/Wall-mounted
Applications: Bilge pumps, ballast pumps, fire pumps, cooling water pumps, deck-wash pumps, fuel pumps, wellpoint pumps, irrigation pumps, circulation pumps.	



Priming Pump and Ejector

The DESMI Priming ejector / pump is designed for mounting on non-selfpriming centrifugal pumps making the pump unit self-priming.	
Max. water flow pumped to drain after completed priming :	Approx. 25 liter/min for 50 Hz / approx. 33 liter/min for 60 Hz power supply. Depending on vacuum level and rpm during priming the water temperature in the pump can rise up to approx. 70°C/158°F within 20 minutes.
Max. allowed water temperature in the pump is	80°C/176°F.

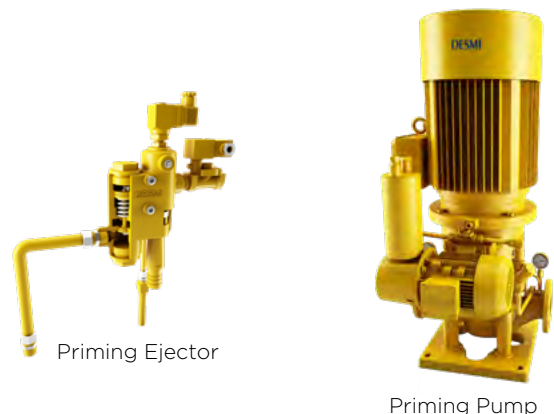

Close Coupled Self-priming Centrifugal Pump

NSA

Close coupled self-priming Centrifugal pump NSA	
Normal Diameter (DN)	50 to 80
Flow rate - 50 Hz	Up to 70 m ³ /h (300 US gpm)
Head	Up to 50 m (160 ft)
Pressure	Up to 12 bar (170 psi)
Temperature	Up to 140°C (284 °F)
Motor	Standard and Ex motor
VFD	Direct or Bulkead/Wall-mounted
Applications: Bilge pumps, ballast pumps, general service pumps, emergency fire pumps, cooling water pumps	



NSA

Dirty Water Vacuum Pump

VAC

Horizontal Self-priming Centrifugal pump VAC	
Normal Diameter (DN)	65 & 100
Flow rate - 50 Hz	Up to 70m ³ /h (300 US gpm)
Flow rate - 60 Hz	Up to 70m ³ /h (300 US gpm)
Head	Up to 19 m (60 ft)
Pressure	Up to 3.5 bar (50 psi)
Temperature	Up to 80 °C (176 °F)
Motor	Standard and Ex motor
VFD	Direct or Bulkead/Wall-mounted
Applications: (Emergency) bilge pumps, bilge-ballast pumps, general service pumps, vacuum pumps, gland-leaking water pumps, chemical industries, draining holds, emptying vessels, well point systems	



VAC

DESMI Submerged Lubrication Oil Pump

The DESLUBE series is a submerged deep-well pump designed for main engine lube oil supply for large two-stroke engines.

DESLUBE

Vertical Deepwell multistage Centrifugal pump DESLUBE	
Normal Diameter (DN)	150 to 300
Flow rate - 50 Hz	Up to 880 m ³ /h (3900 US gpm)
Flow rate - 60 Hz	Up to 1050 m ³ /h (4600 US gpm)
Head	Up to 125 m (410 ft)
Pressure	Up to 20 bar (290 psi)
Temperature	Up to 80 °C (176 °F)
Motor	Standard and Ex motor
VFD	Direct or Bulkead/Wall-mounted
Applications: The DESLUBE series is a submerged deep well pump designed for main engine lubrication oil supply for especially large two-stroke engines.	

Benefits:

- Low NPSH
- Low noise
- Low vibration
- Low maintenance costs
- High reliability
- High flexibility



DESLUBE

Design Details

Pumps With \varnothing 215 And \varnothing 265 Impeller
Suction and discharge flange dimensions are identical. The line through inlet and outlet is flush with the centre line of the shaft. The pumps are mounted with one impeller wear ring.

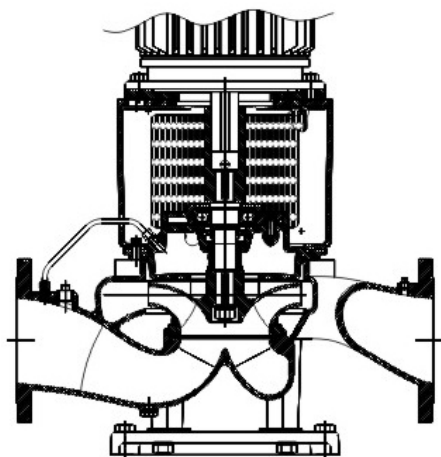

Pumps With \varnothing 330, \varnothing 415 and \varnothing 525 Impeller
Dimension of the suction flange is one size larger than that of the discharge flange. The line through inlet and outlet is tangential offset in relation to the centre line of the shaft. The pumps have two impeller wear rings.

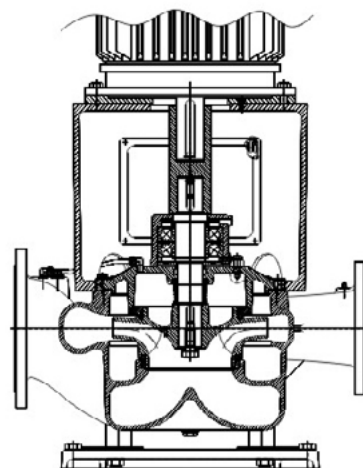

Monobloc With Bearing

The pump is for major capacities and heavy loads, especially recommended where the advantage of the spacer coupling is of no importance and where a small overall height is required.

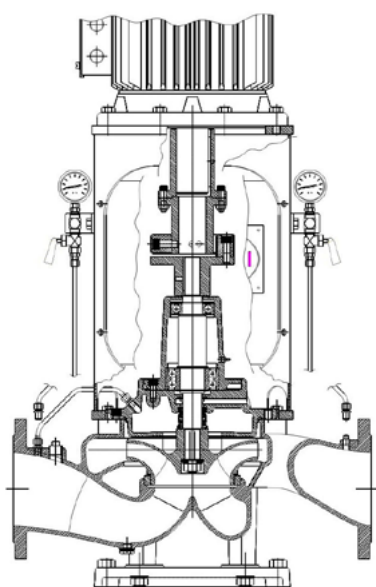

The pump is equipped with a separate rear cover with a ball bearing and a separate motor bracket. Dismantling of the rotating pump parts is possible without removing the pump casing from the piping.

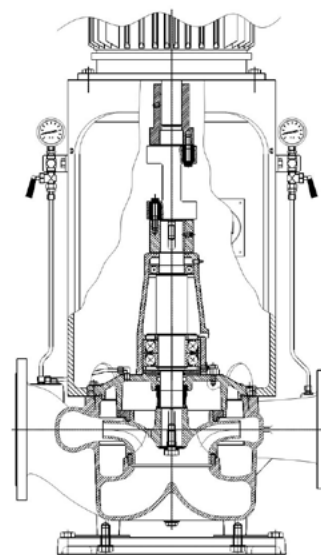

Spacer

The pump is for high capacities, heavy loads, and high pump speeds. As a special feature the pump is equipped with a spacer coupling which is a combined distance and flexible coupling. This makes it possible to remove the complete bearing housing with shaft, bearings, shaft seal, and impeller without dismantling or loosening the motor or piping.

For high capacities and the resulting larger and heavier electric motors we recommend this pump version because of the easy dismantling of the rotating pump parts in connection with inspection and repair. This special feature is often a requirement within the marine industry where installations must be easy to service.

DESMI Centrifugal Pumps - DSL 50Hz



DSL Centrifugal Pump, 960 rpm, **50 HZ**

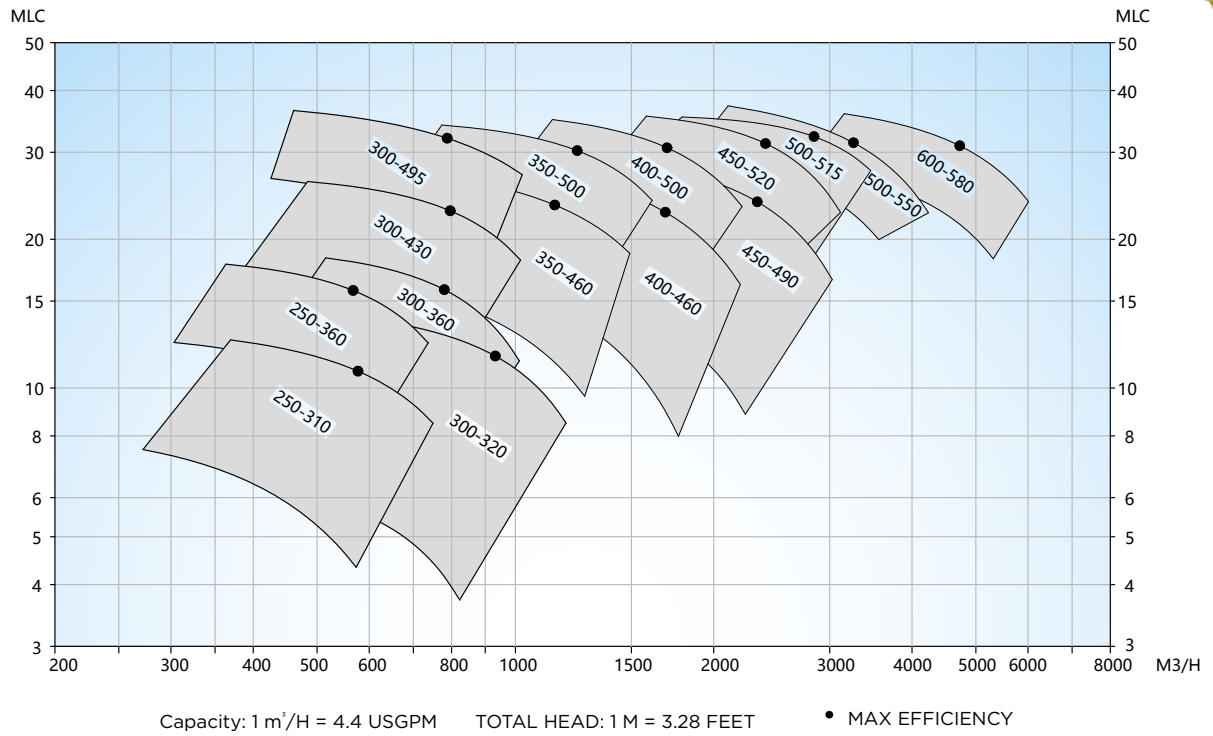

DSL Centrifugal Pump, 1450 rpm, **50 HZ**

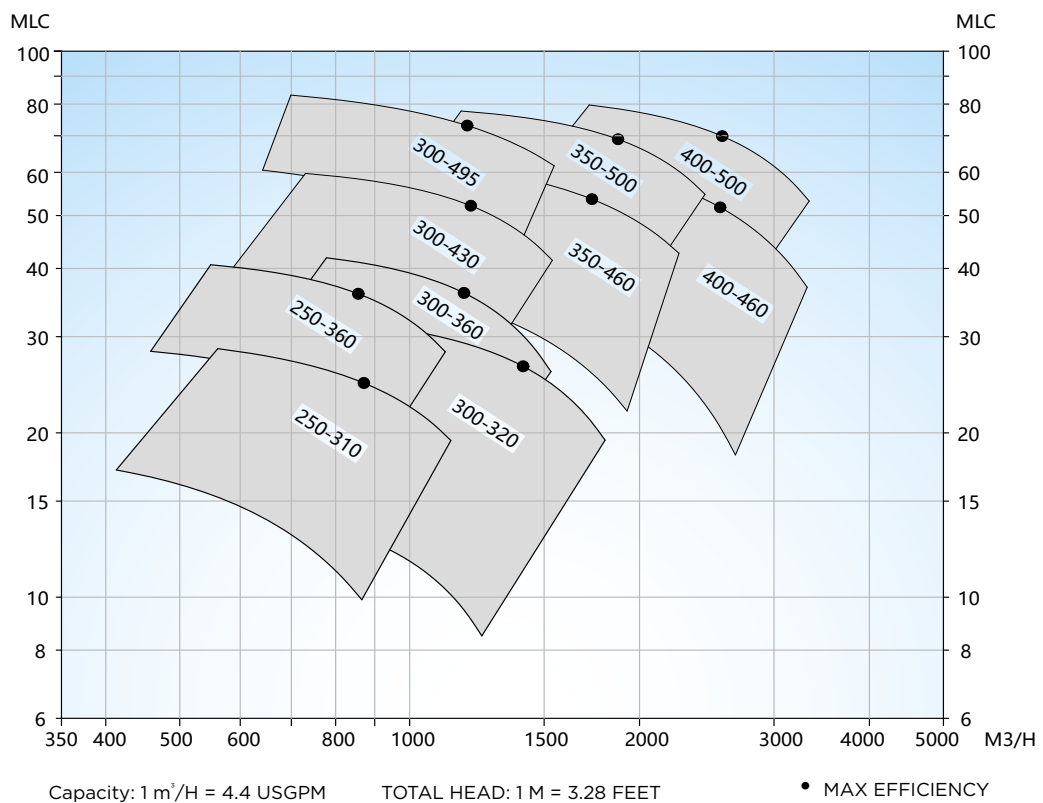

DSL Centrifugal Pump, 1152 rpm, **60 HZ**

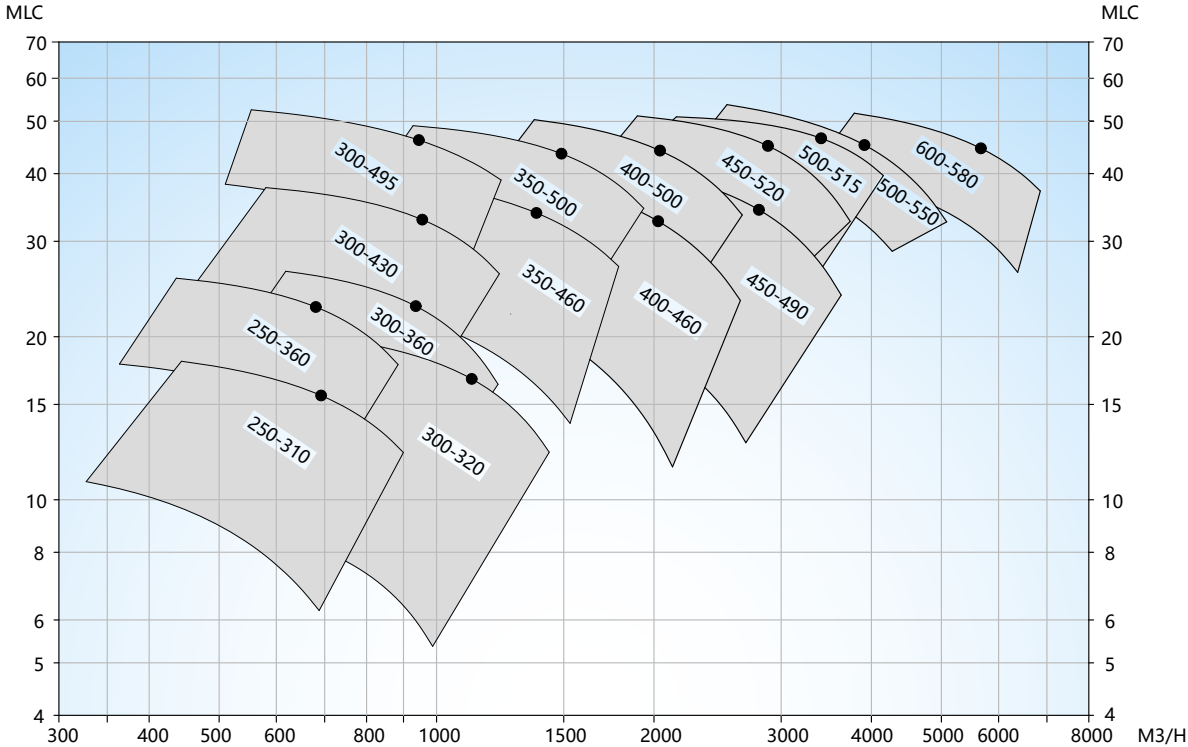

Capacity: 1 m³/H = 4.4 USGPM TOTAL HEAD: 1 M = 3.28 FEET • MAX EFFICIENCY

DSL Centrifugal Pump, 1740 rpm, **60 HZ**

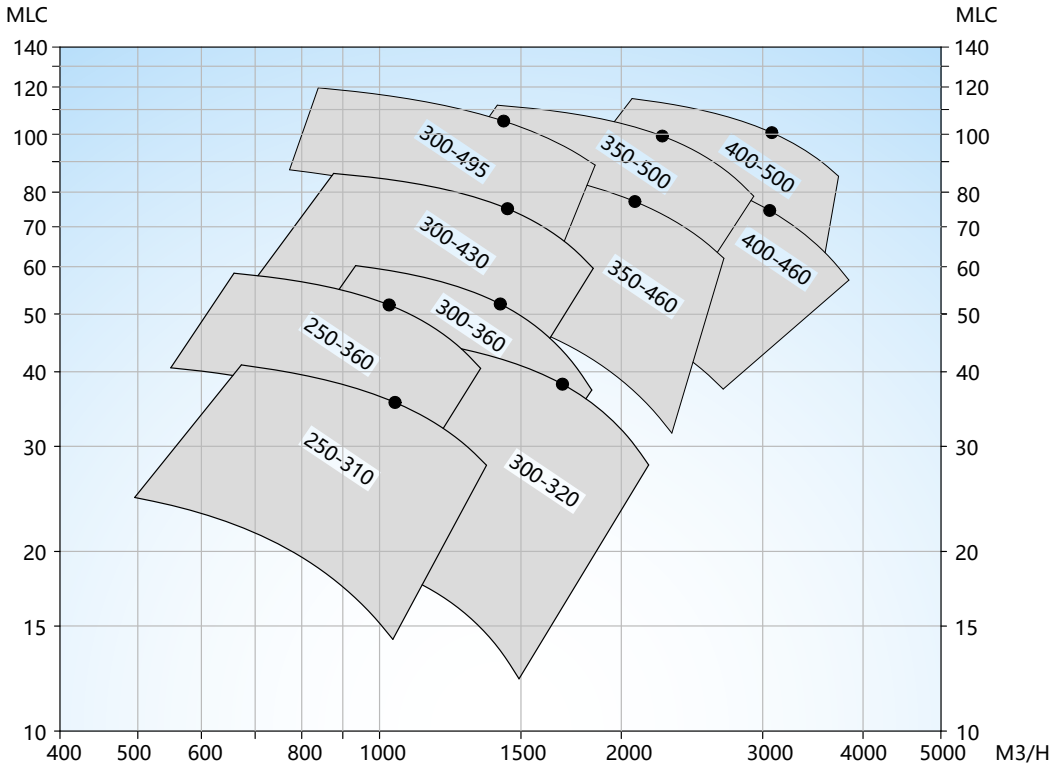

Capacity: 1 m³/H = 4.4 USGPM TOTAL HEAD: 1 M = 3.28 FEET • MAX EFFICIENCY

DESMI Centrifugal Pumps - ESL 50Hz



ESL Centrifugal Pump, 960 rpm, **50 HZ**

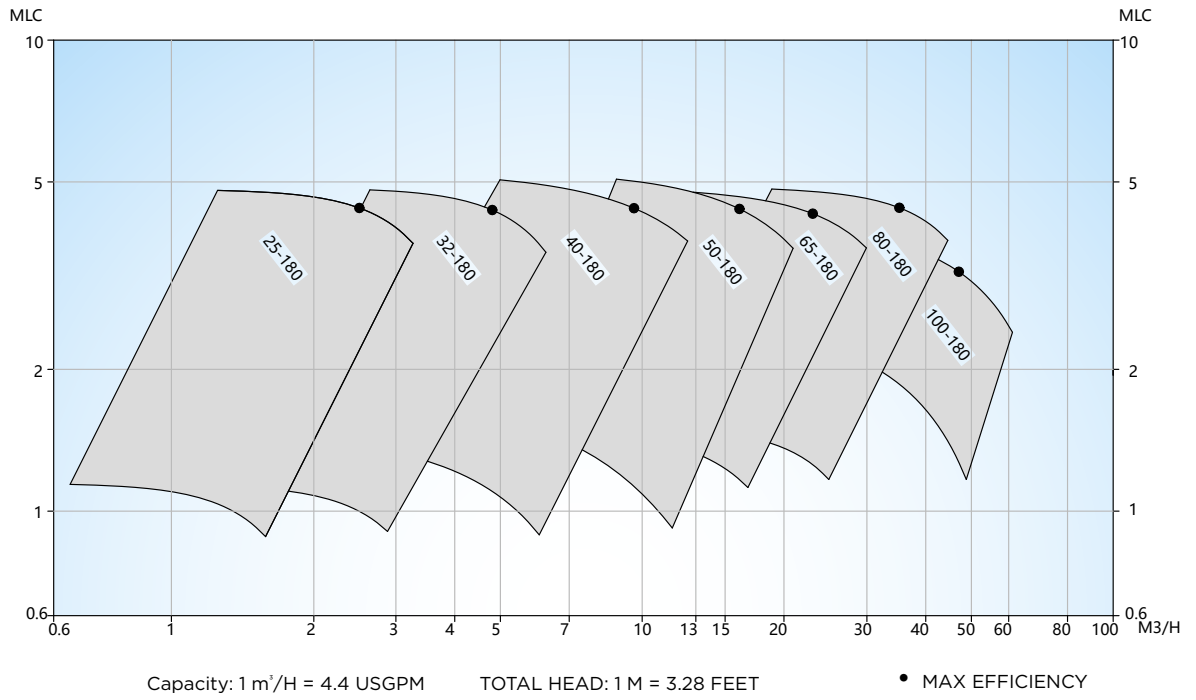

ESL Centrifugal Pump, 1450 rpm, **50 HZ**

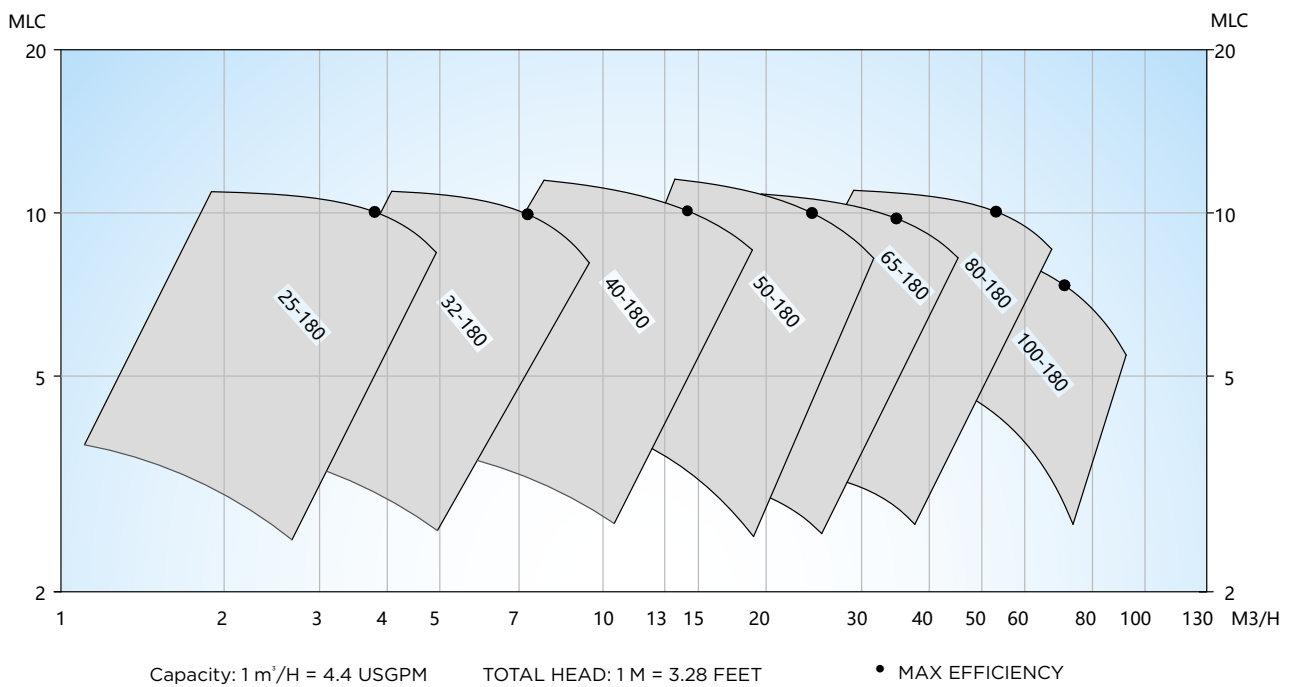

ESL Centrifugal Pump, 2950 rpm, **50 HZ**

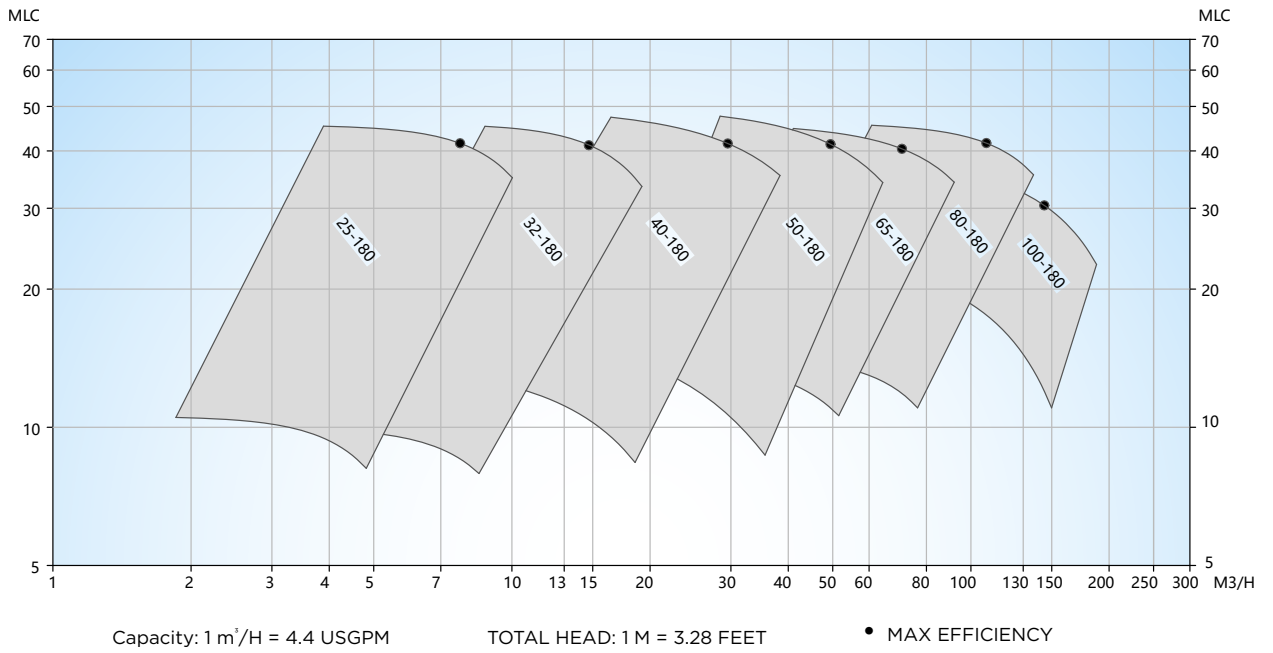

DESMI Centrifugal Pumps - ESLHT



ESLTH Centrifugal Pump, 2950 rpm, **50 HZ**

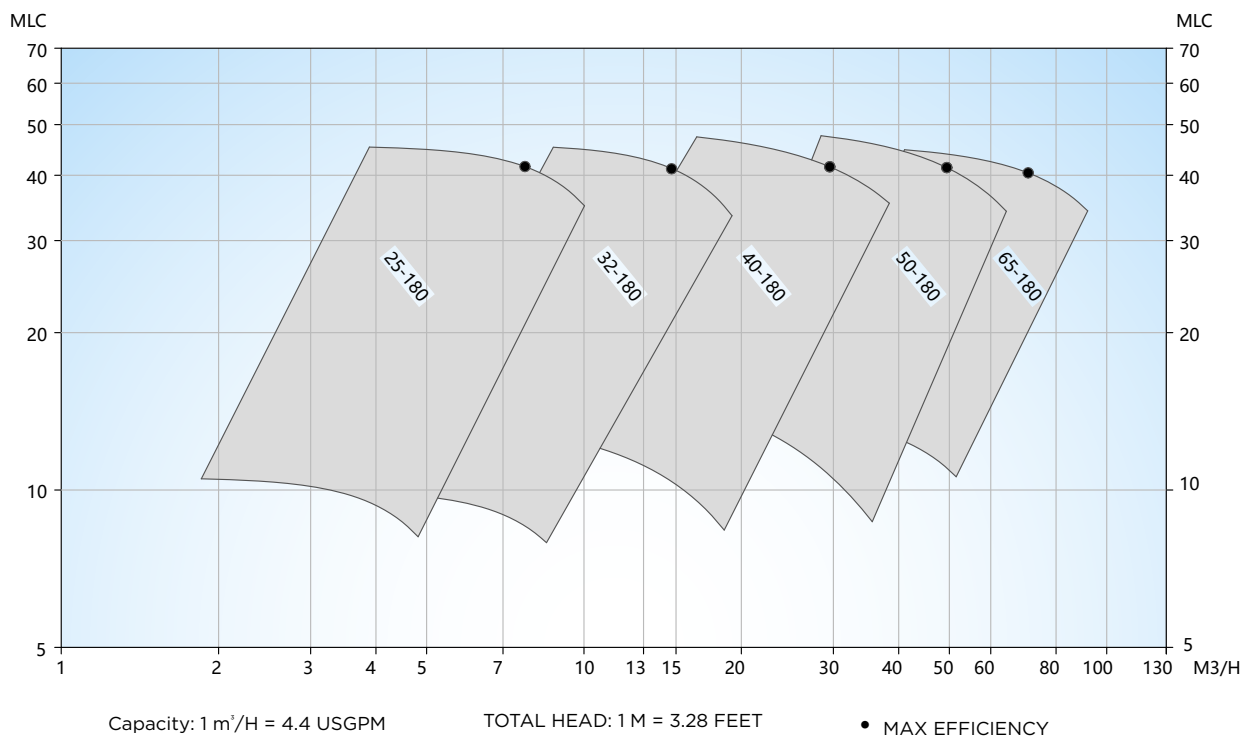

DESMI Centrifugal Pumps - ESL 50Hz



ESL Centrifugal Pump, 1152 rpm, **60 Hz**

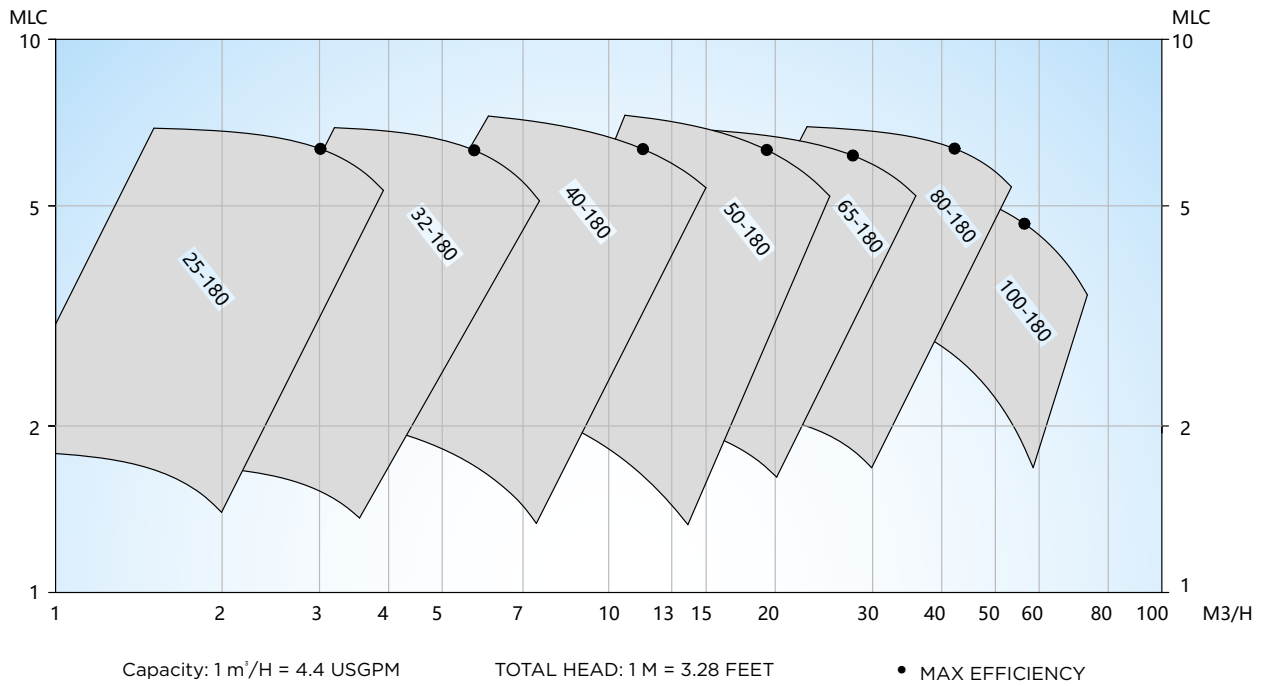

ESL Centrifugal Pump, 1740 rpm, **60 Hz**

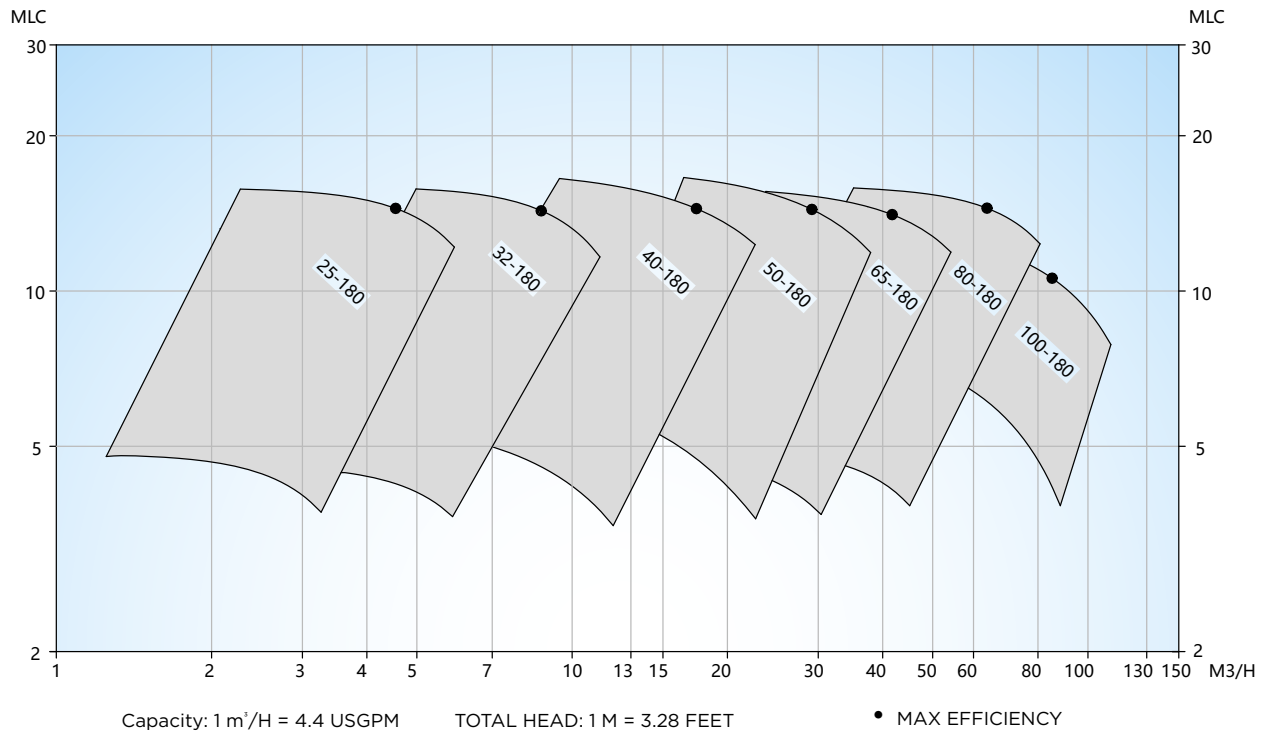

DESMI Centrifugal Pumps - ESL

ESL Centrifugal Pump, 3450 rpm, **60 HZ**

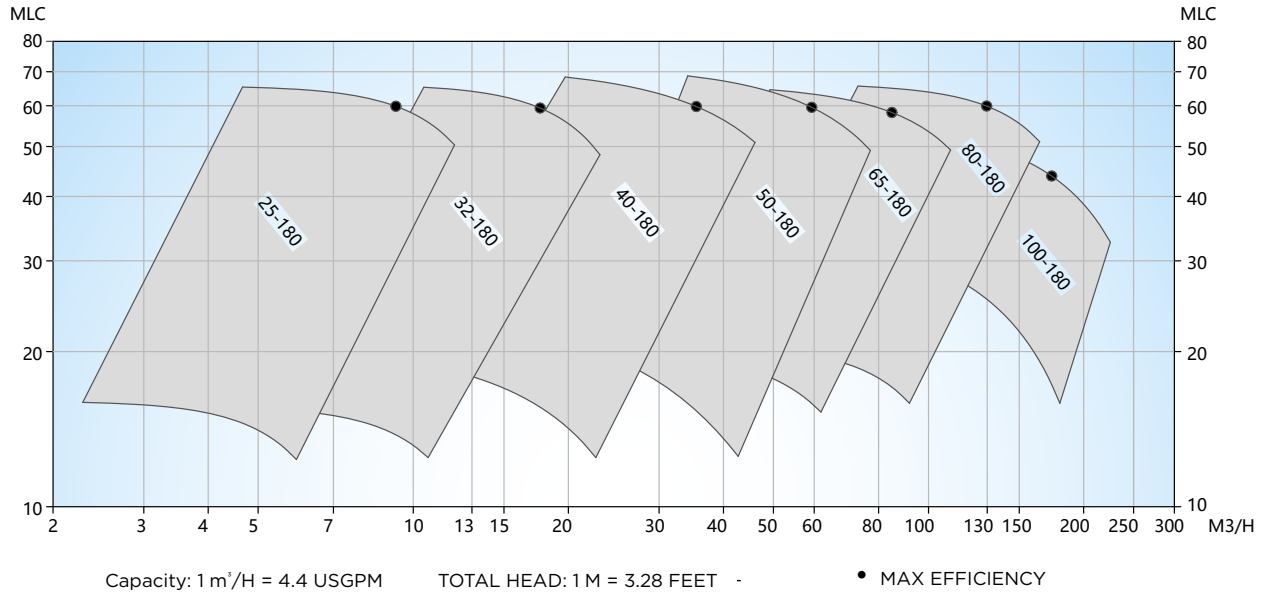

DESMI Centrifugal Pumps - ESLHT

ESLTH Centrifugal Pump, 3450 rpm, **60 HZ**

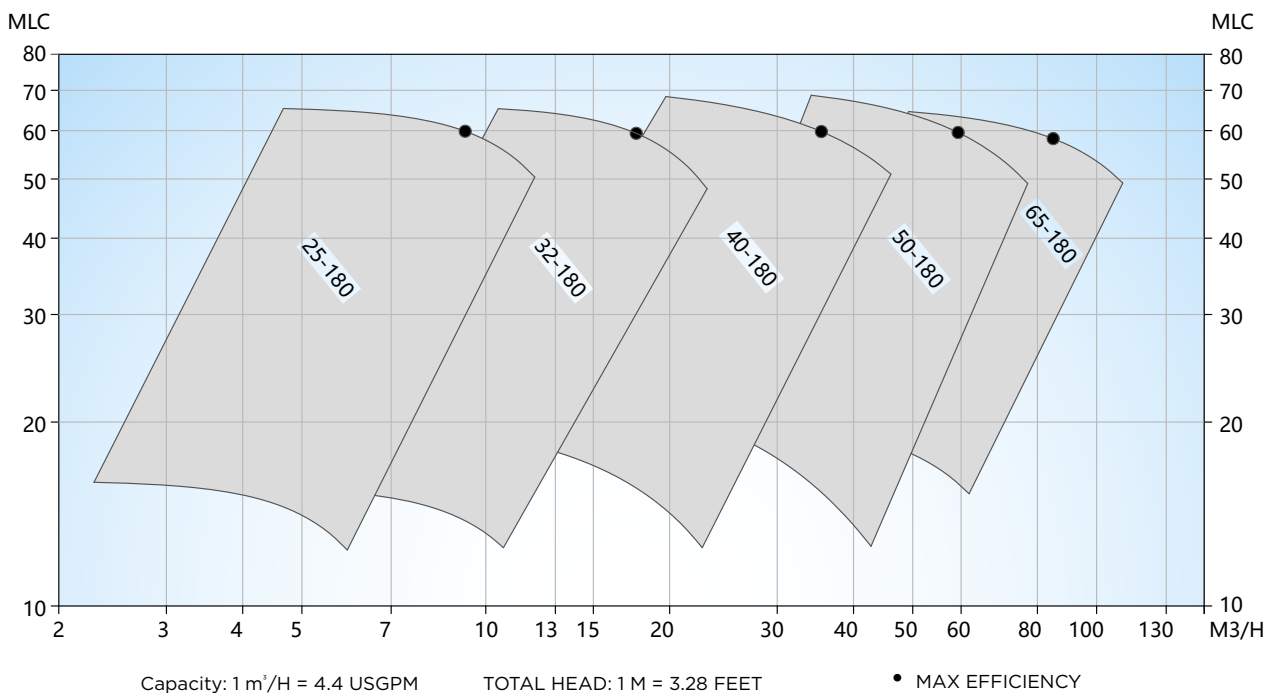

DESMI Centrifugal Pumps - Modular S 50Hz



S Centrifugal Pump, 960 rpm, **50 HZ**

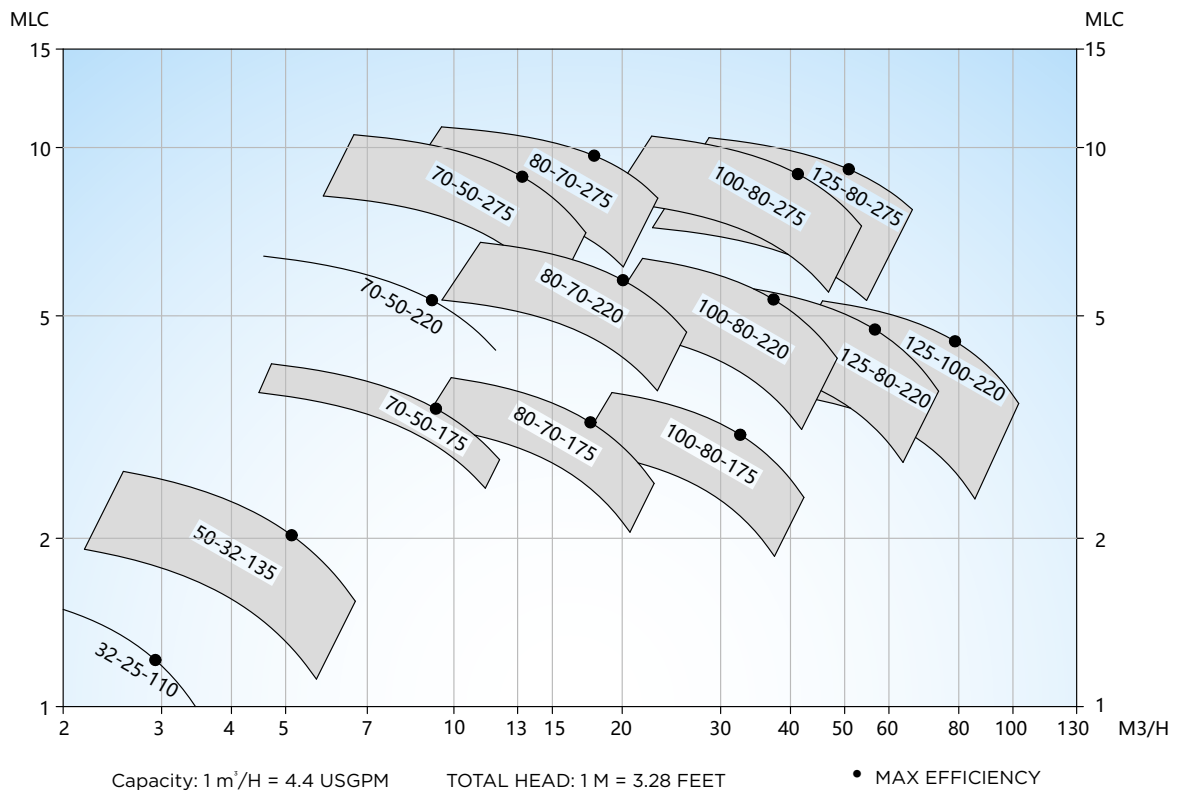

DESMI Centrifugal Pumps - Modular S 50Hz

S Centrifugal Pump, 1450 rpm, **50 Hz**

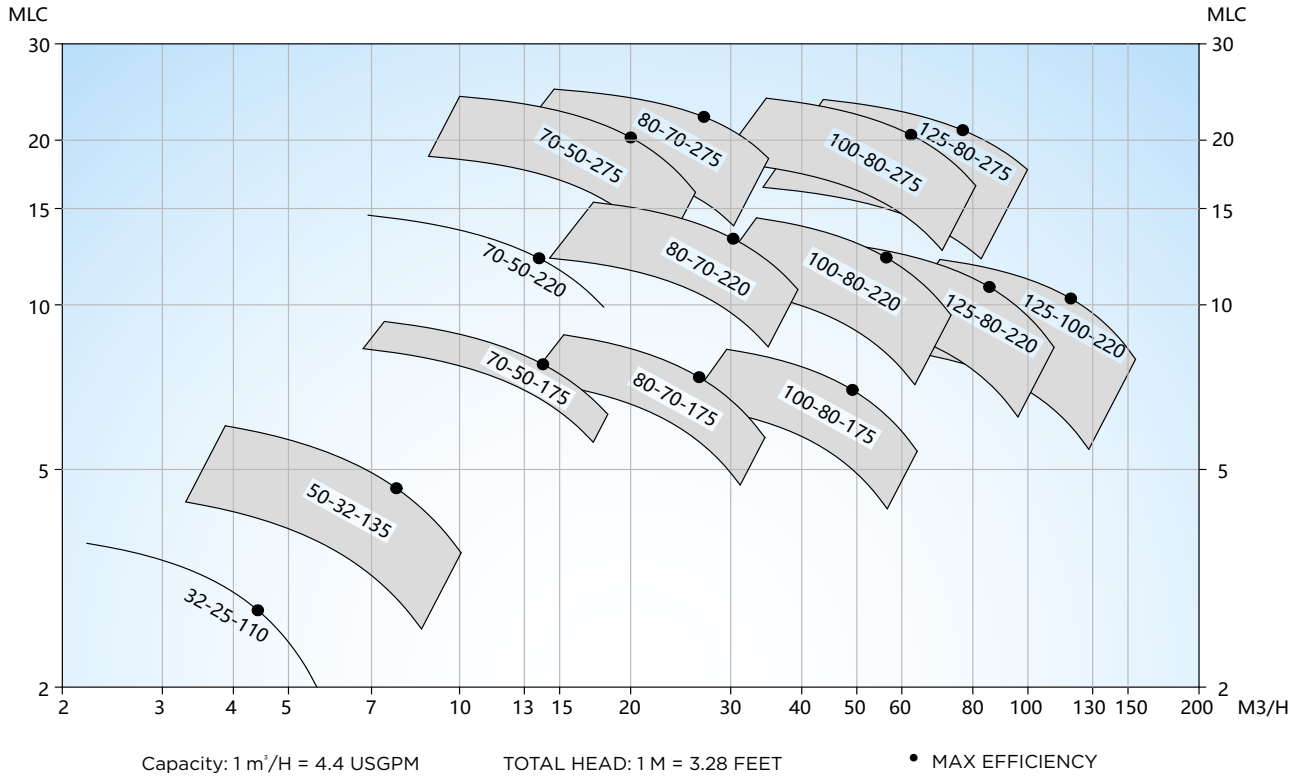

S Centrifugal Pump, 2950 rpm, **50 Hz**

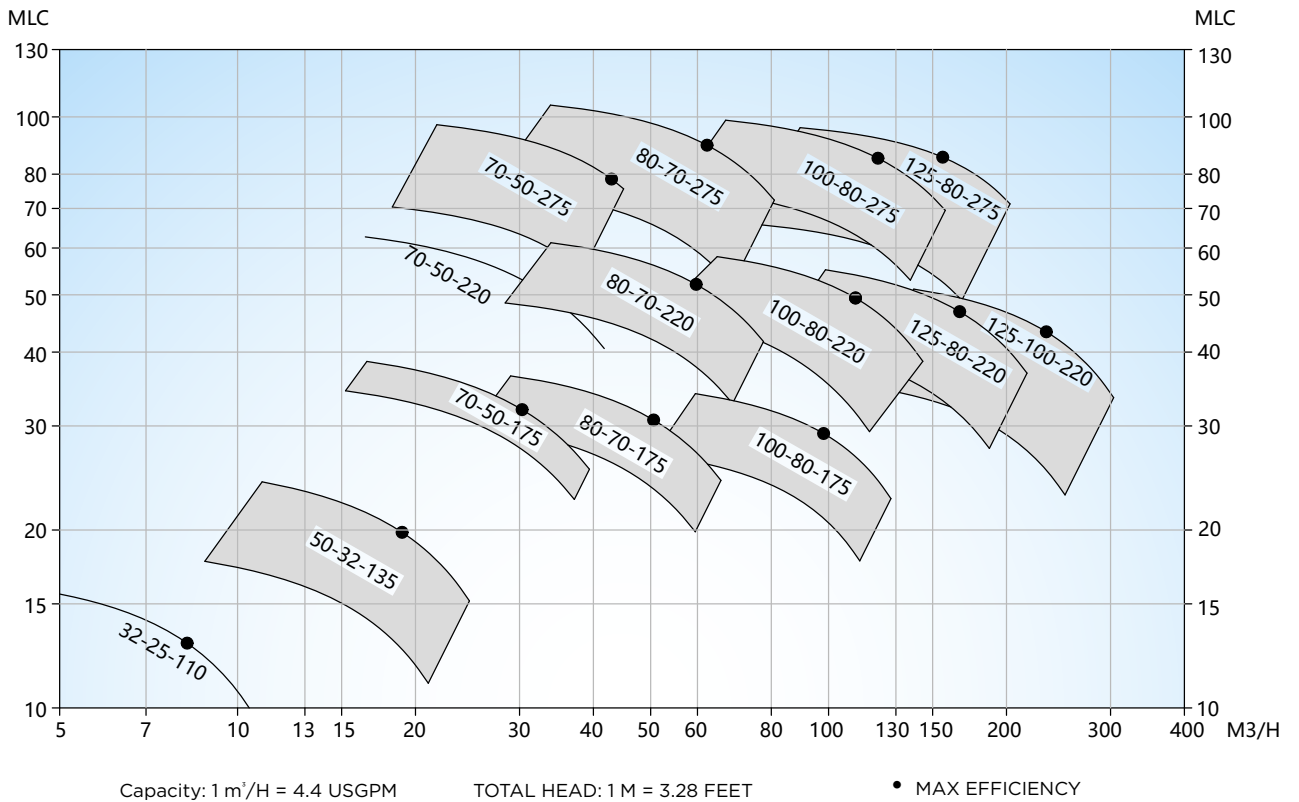

DESMI Centrifugal Pumps - Modular S 60Hz

S Centrifugal Pump, 1152 rpm, **60 HZ**

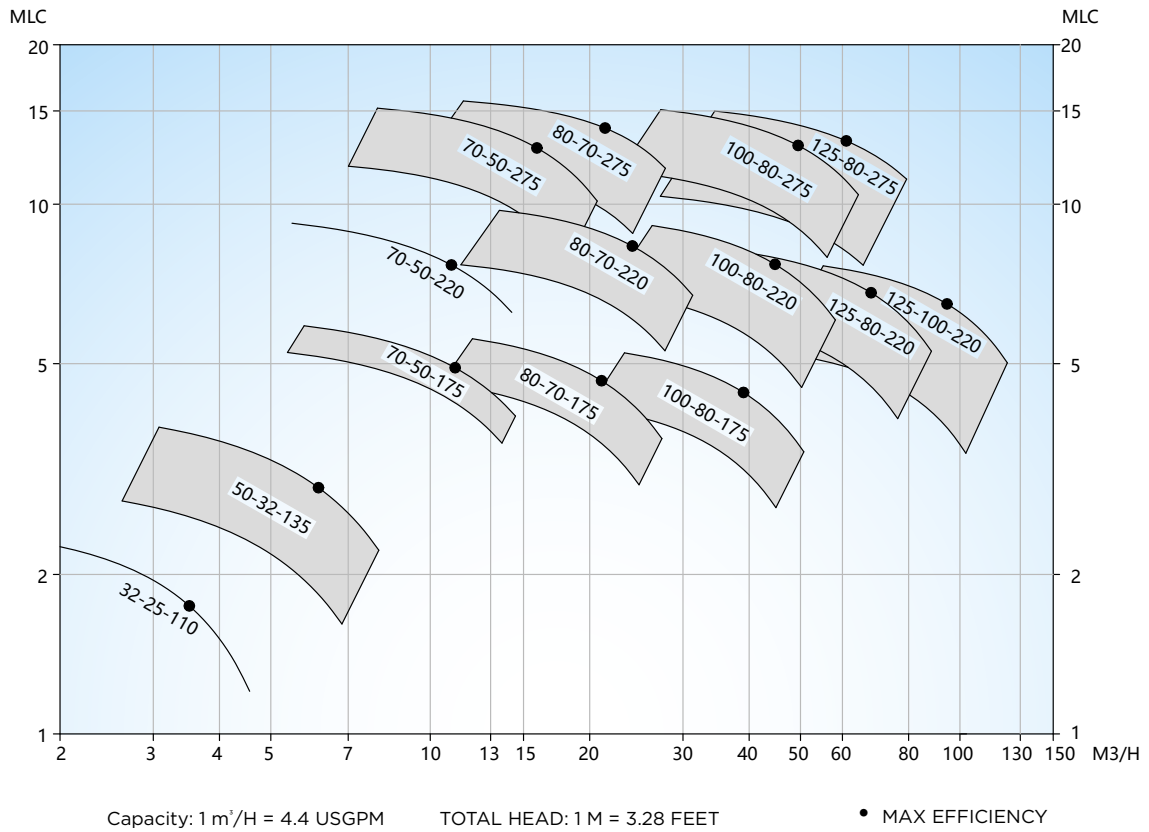

S Centrifugal Pump, 1740 rpm, **60 HZ**

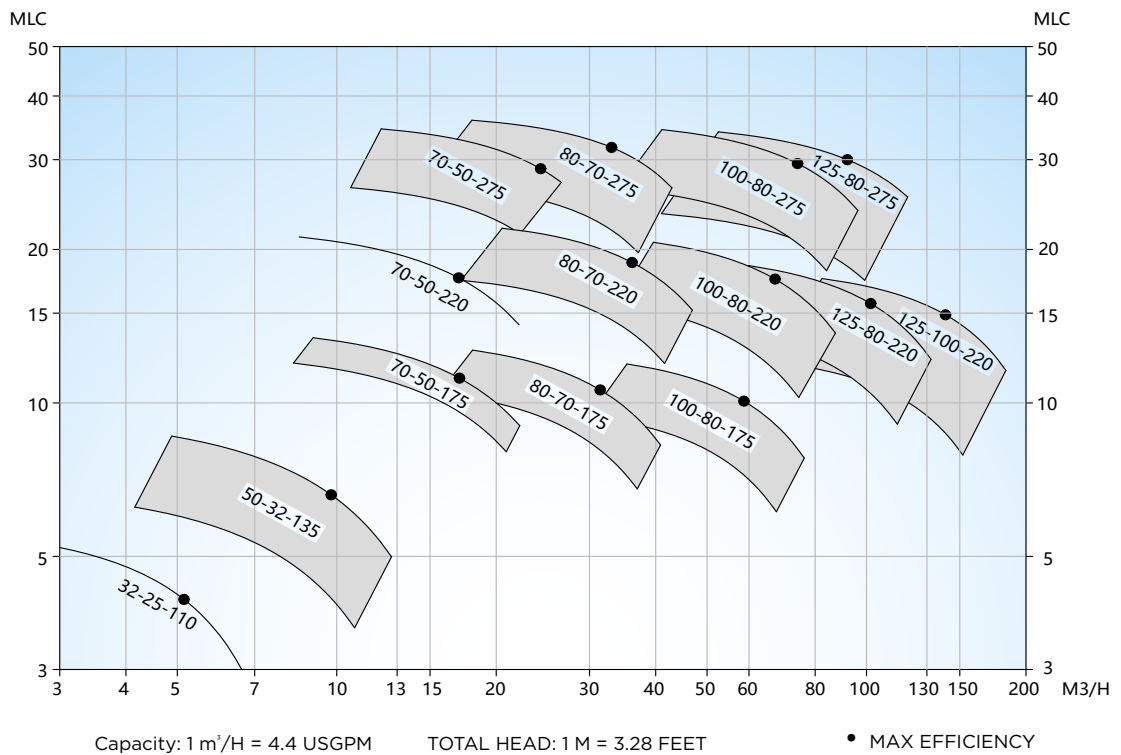

DESMI Centrifugal Pumps - Modular S 60Hz

S Centrifugal Pump, 3450 rpm, **60 HZ**

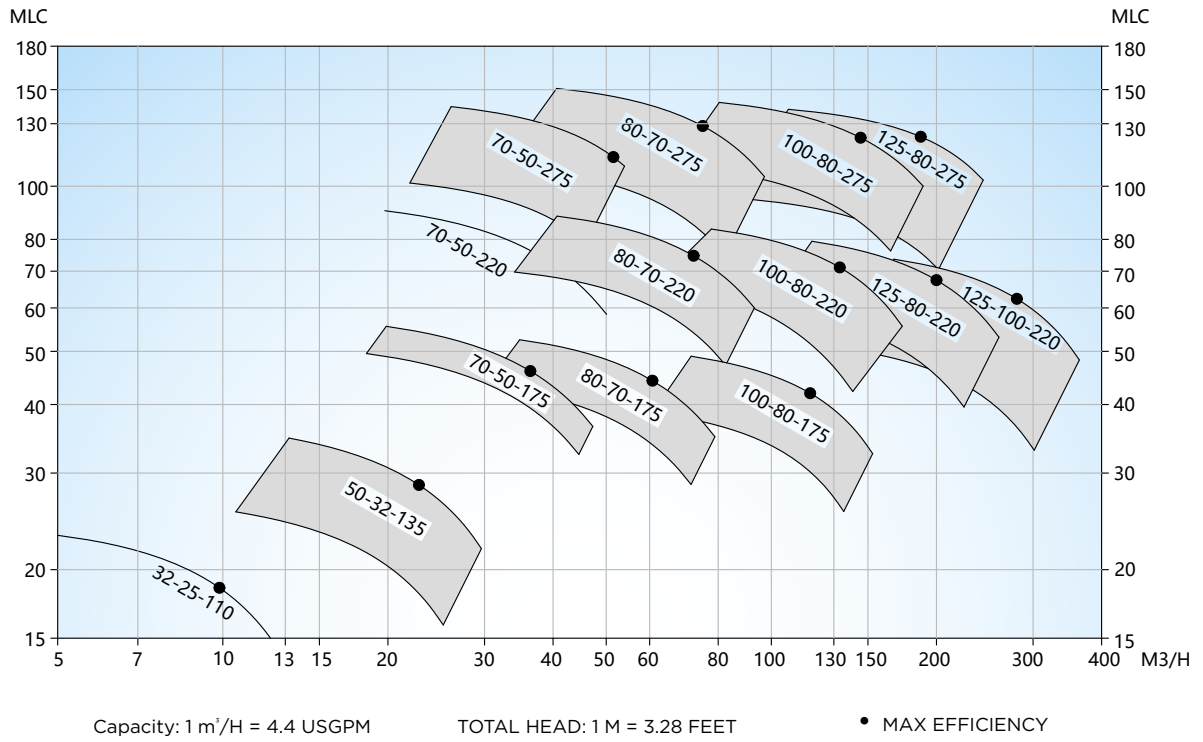

DESMI Centrifugal Pumps - NSL 50Hz



NSL Centrifugal Pump, 960 rpm, **50 Hz**

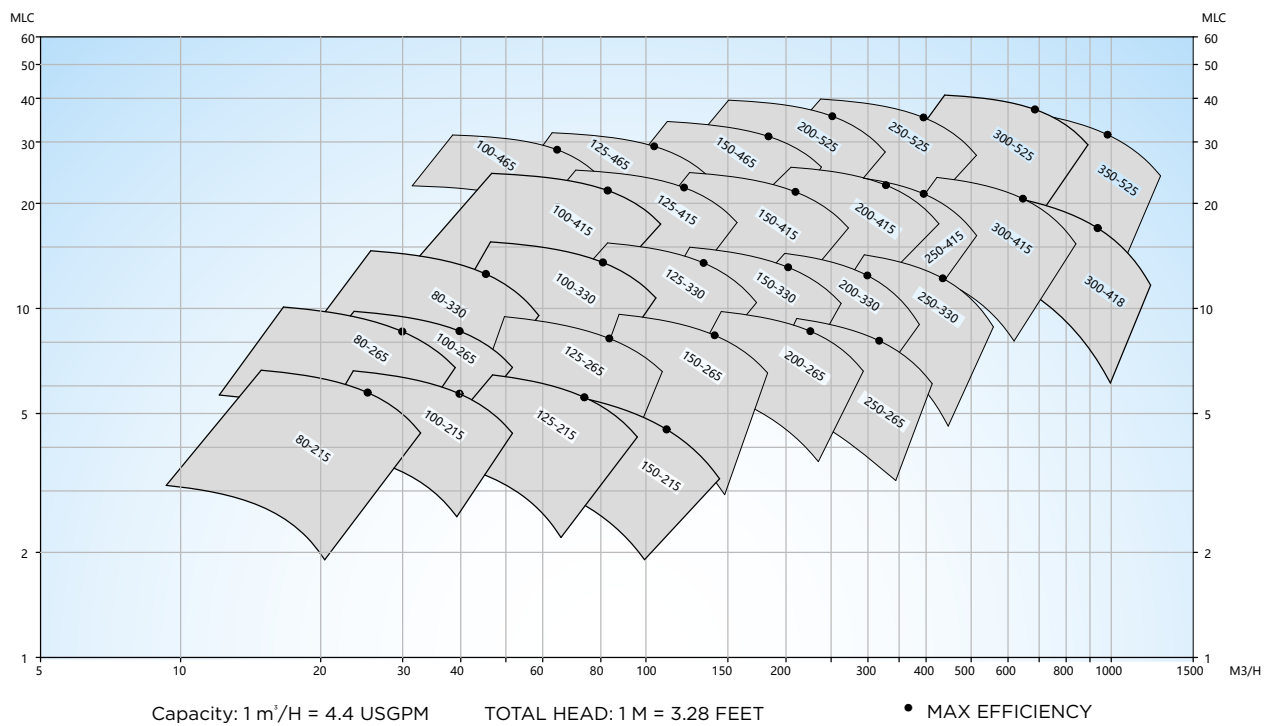

NSL Centrifugal Pump, 1450 rpm, **50 HZ**

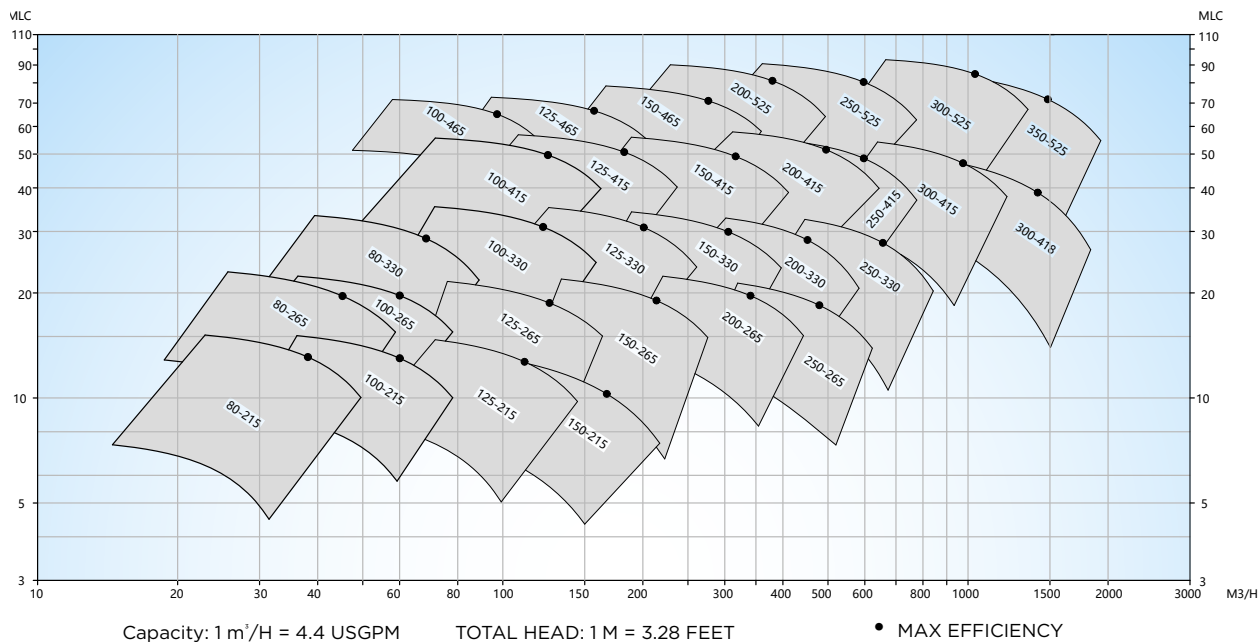

NSL Centrifugal Pump, 2950 rpm, **50 HZ**

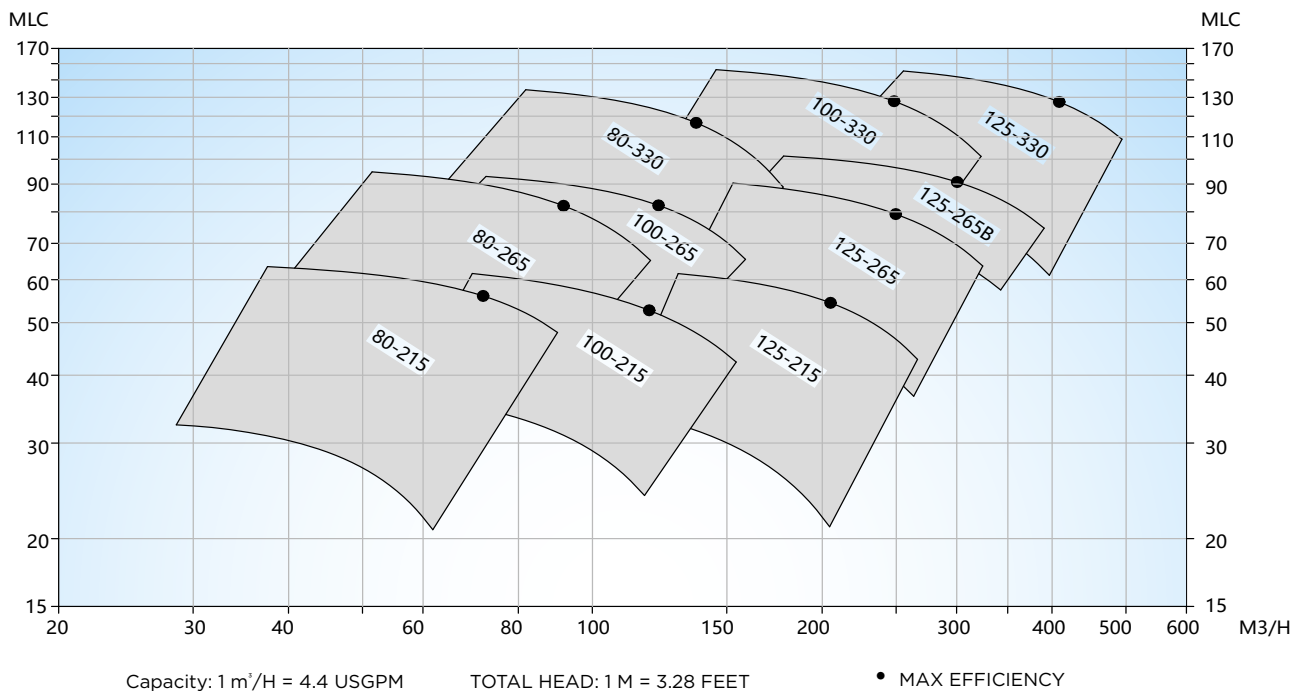

DESMI Centrifugal Pumps - NSL 60Hz

NSL Centrifugal Pump, 1152 rpm, **60 HZ**

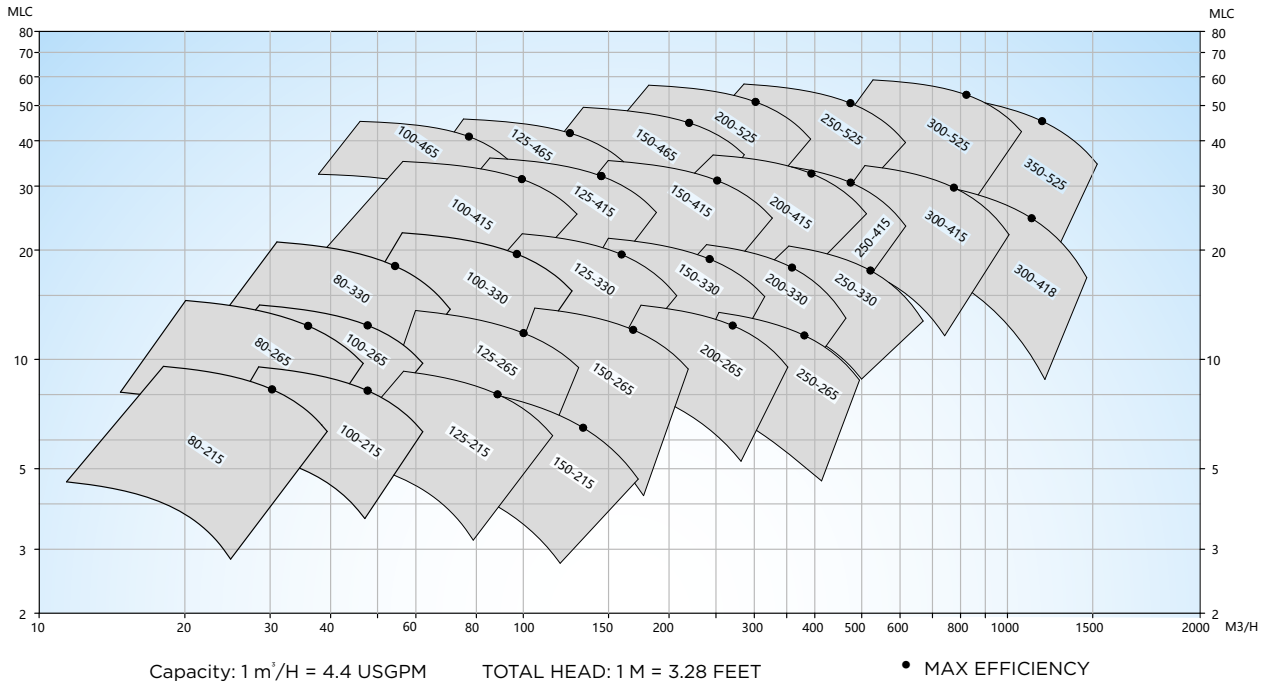

NSL Centrifugal Pump, 1740 rpm, **60 HZ**

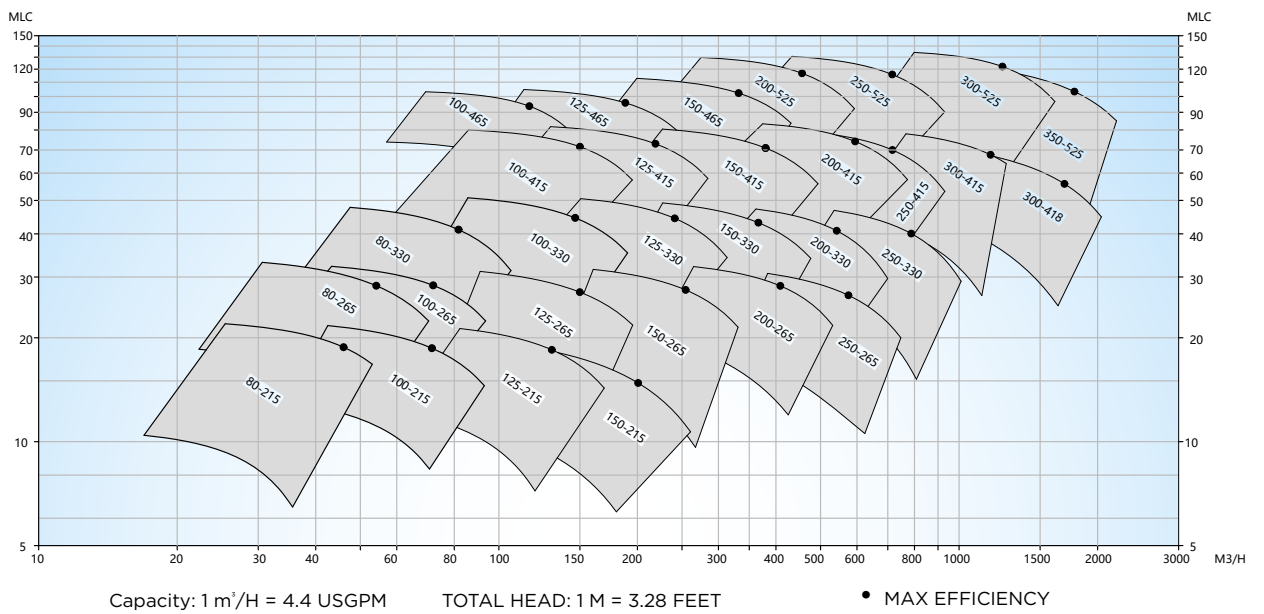

DESMI Centrifugal Pumps - NSL 60Hz

NSL Centrifugal Pump, 3450 rpm, **60 HZ**

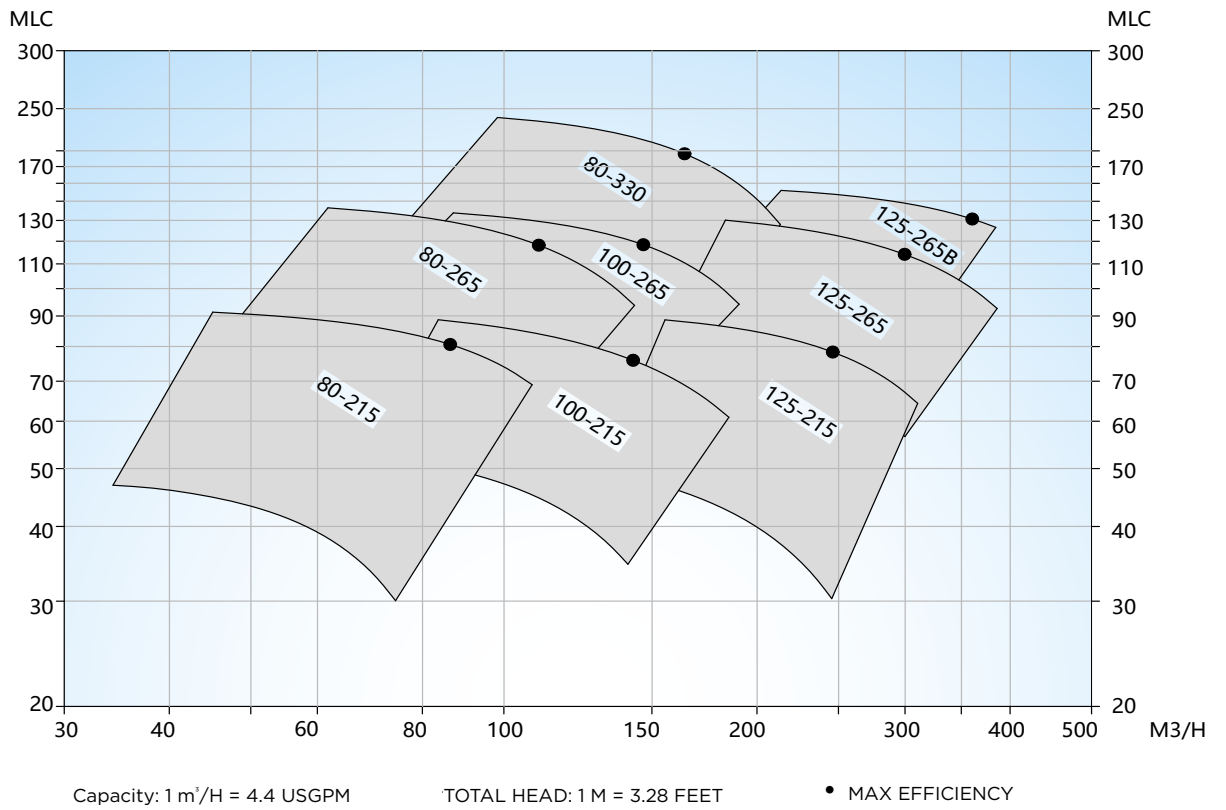

DESMI Centrifugal Pumps - SA 50Hz

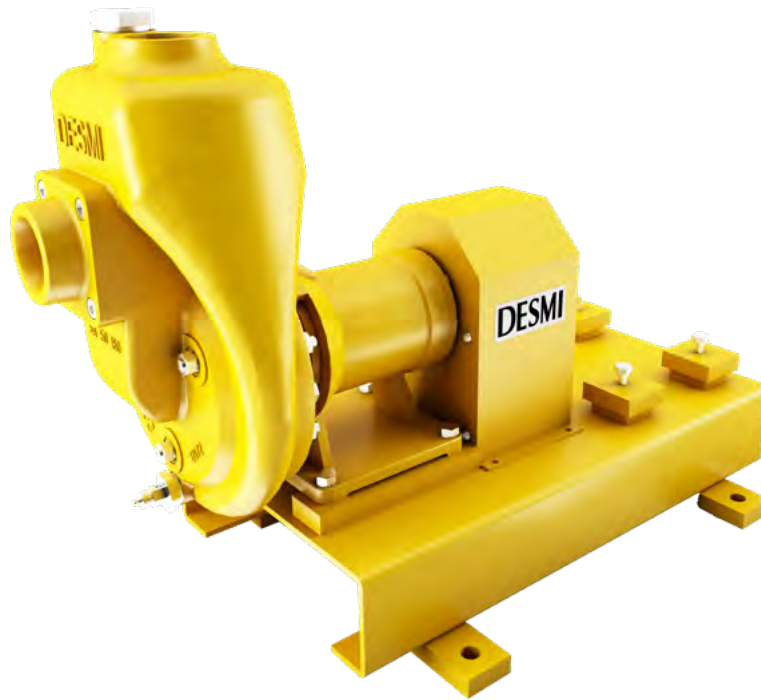

SA Centrifugal Pump, 960 rpm, **50 HZ**

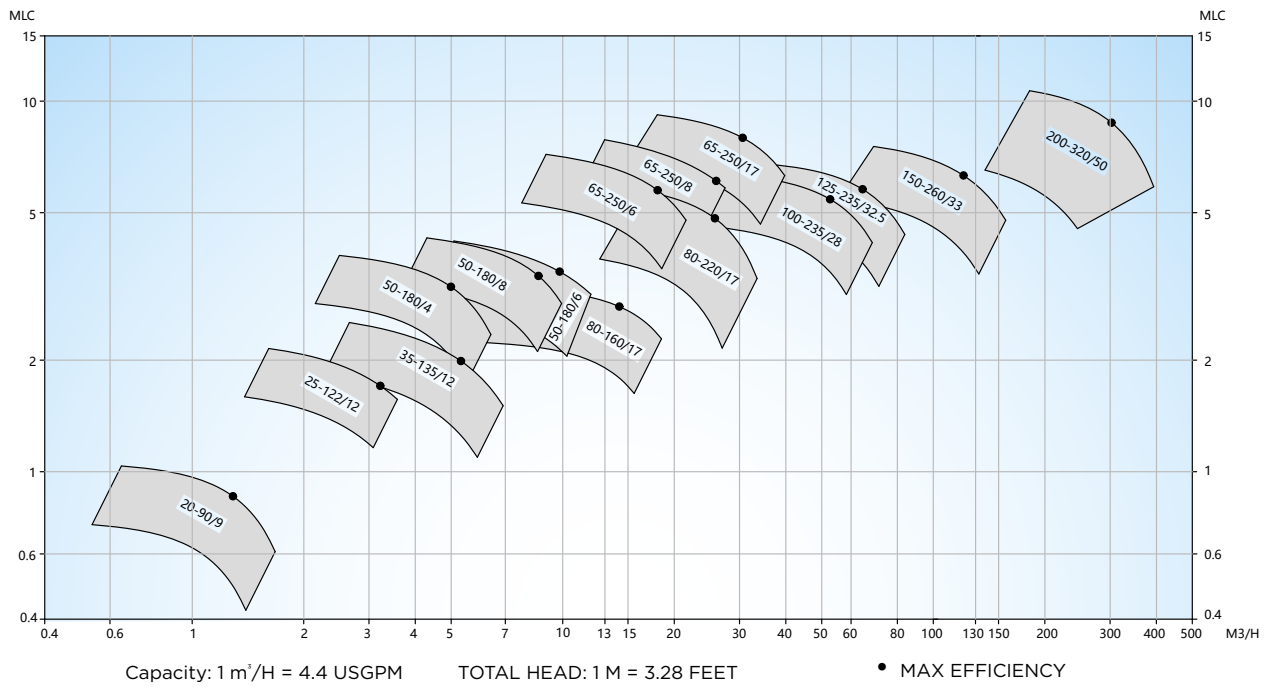

SA Centrifugal Pump, 1450 rpm, 50 Hz

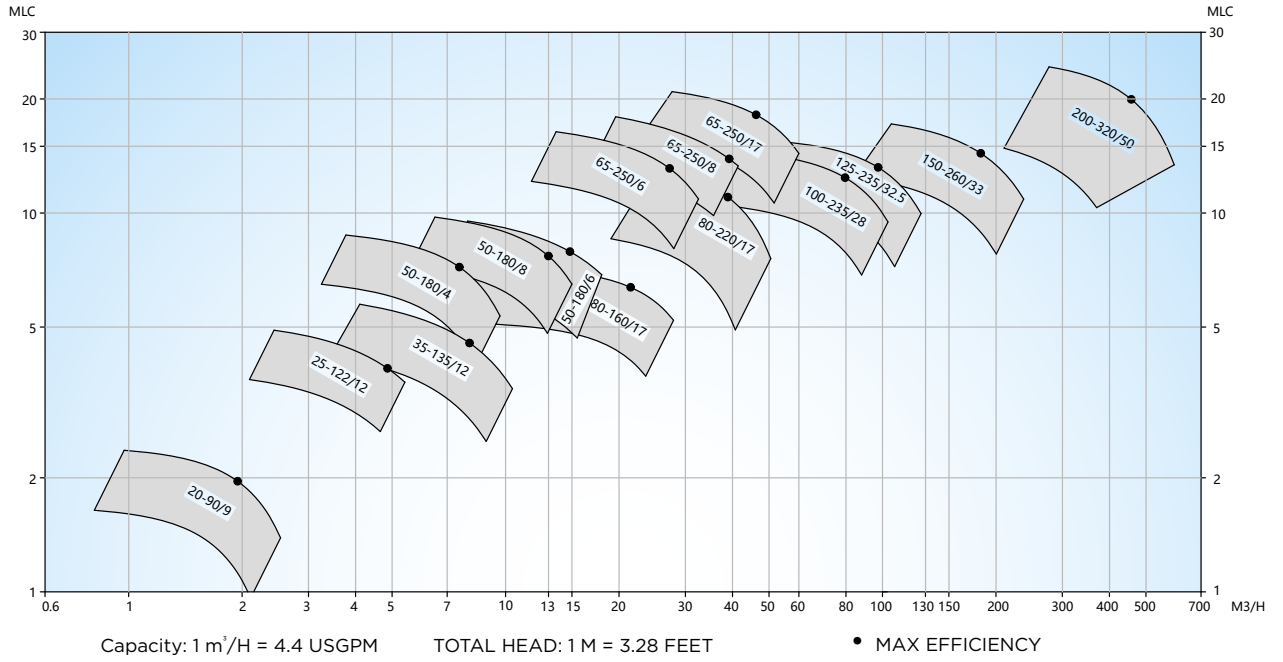

SA Centrifugal Pump, 2950 rpm, 50 Hz

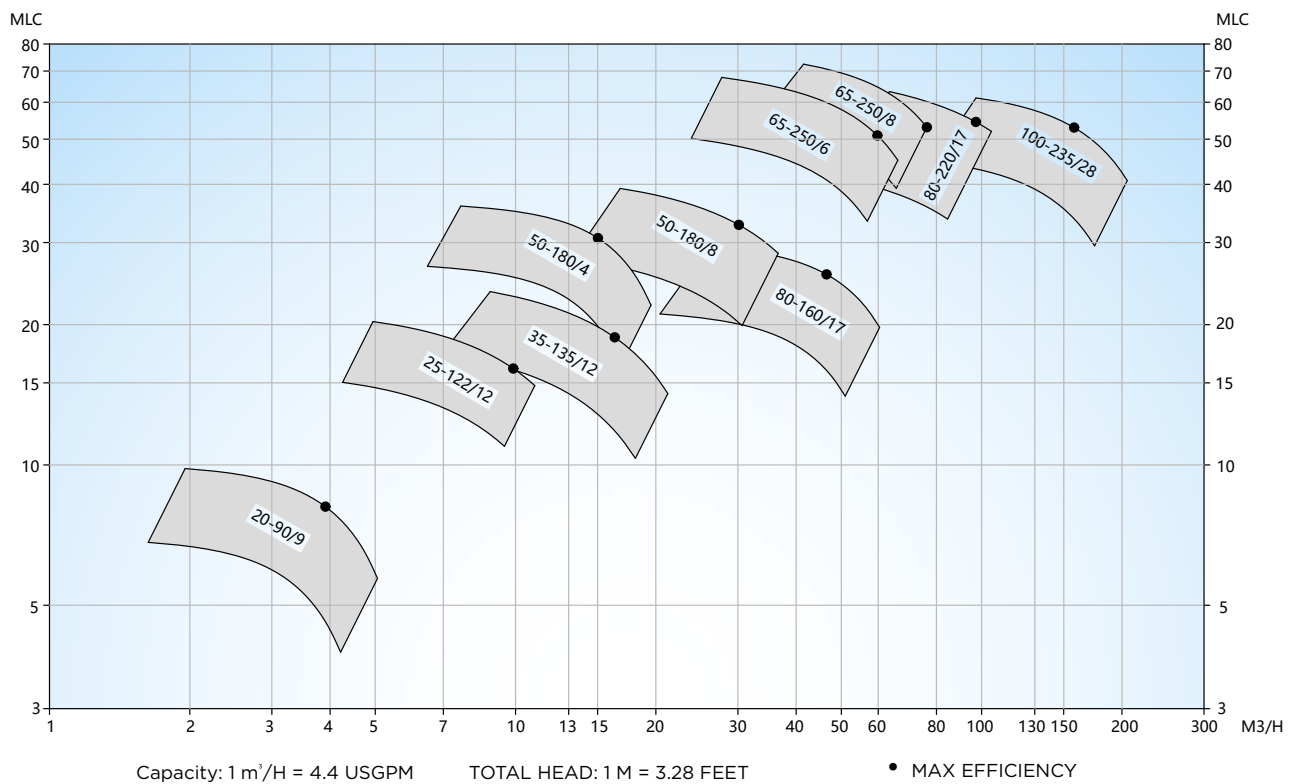

DESMI Centrifugal Pumps - SA 60Hz

SA Centrifugal Pump, 1152 rpm, **60 HZ**

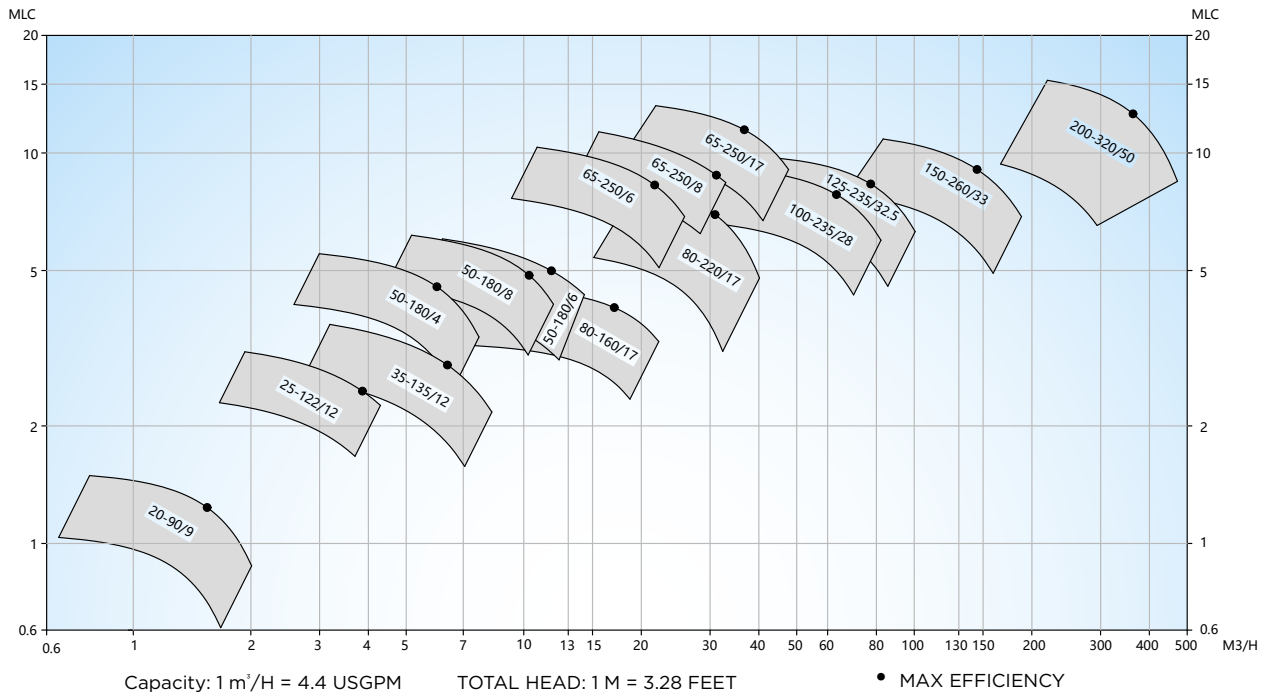

SA Centrifugal Pump, 1740 rpm, **60 HZ**

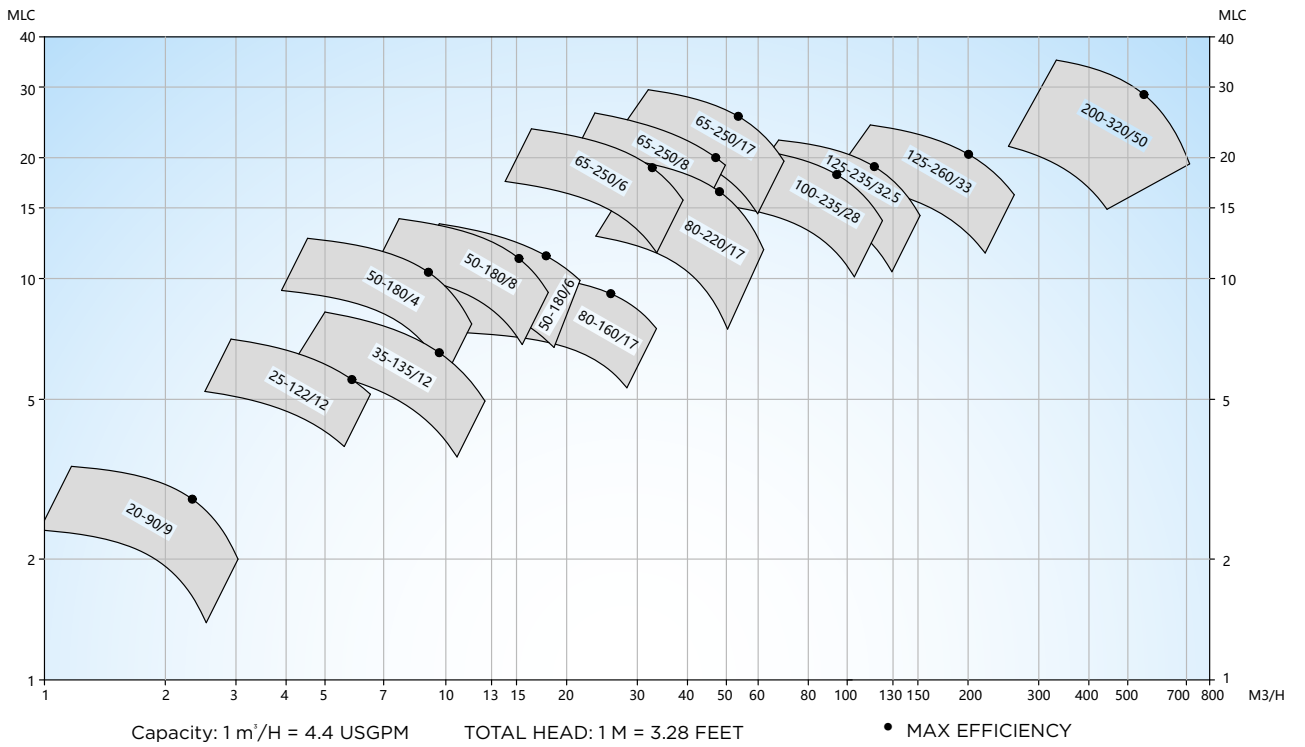

DESMI Centrifugal Pumps - SA 60Hz

SA Centrifugal Pump, 3450 rpm, **60 Hz**

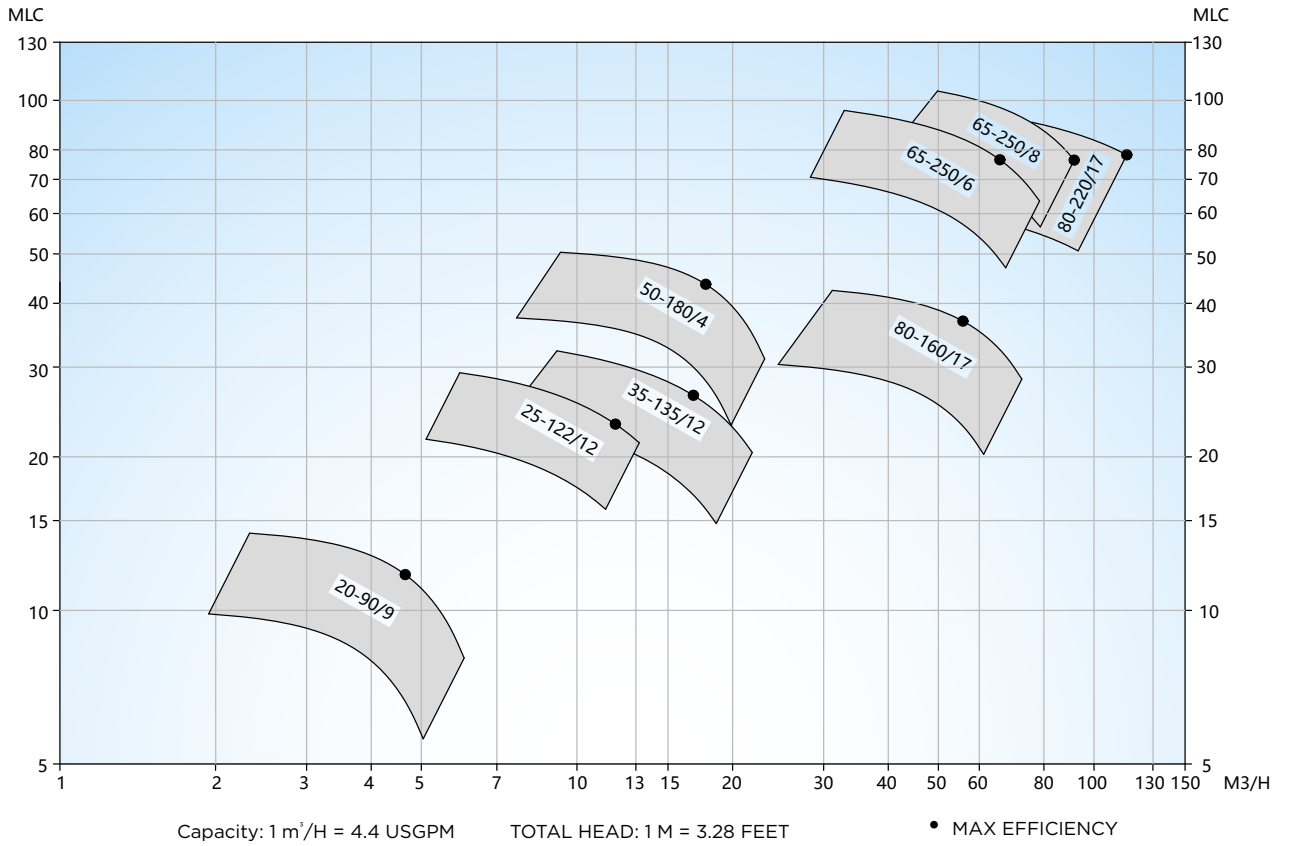

DESMI Centrifugal Pumps - NSA 50Hz



NSA Centrifugal Pump, **50 HZ**

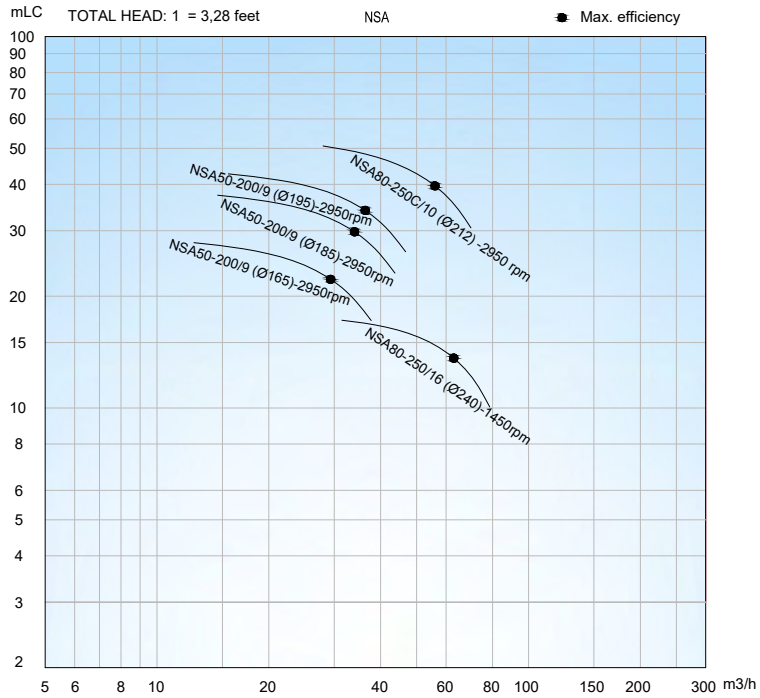

Capacity: 1 m³/H = 4.4 USGPM TOTAL HEAD: 1 M = 3.28 FEET ● MAX EFFICIENCY

DESMI Centrifugal Pumps - VAC 50 & 60Hz



VAC Centrifugal Pump, **50 & 60 HZ**

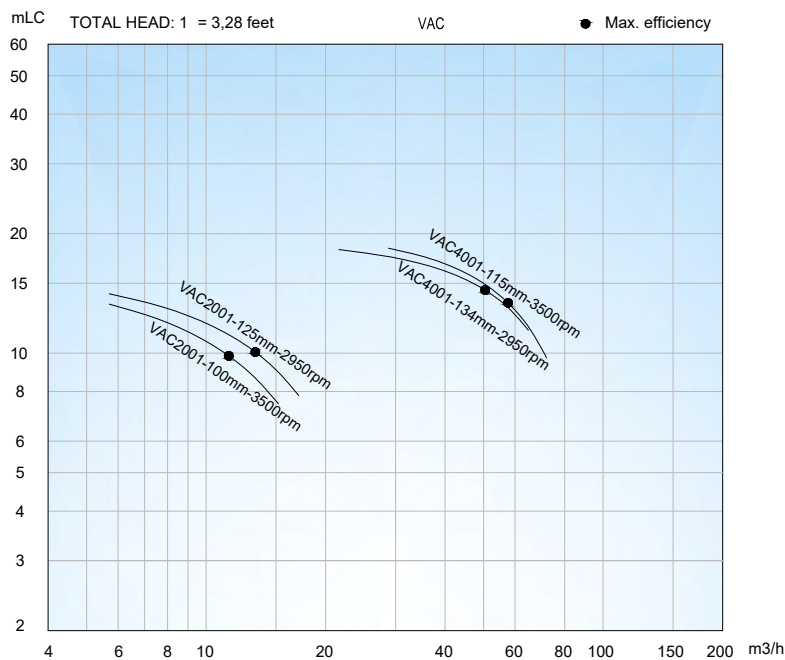

Capacity: 1 m³/H = 4.4 USGPM TOTAL HEAD: 1 M = 3.28 FEET ● MAX EFFICIENCY

DESMI Centrifugal Pumps - TSL 50 og 60 Hz

TSL Centrifugal Pump, 50 HZ

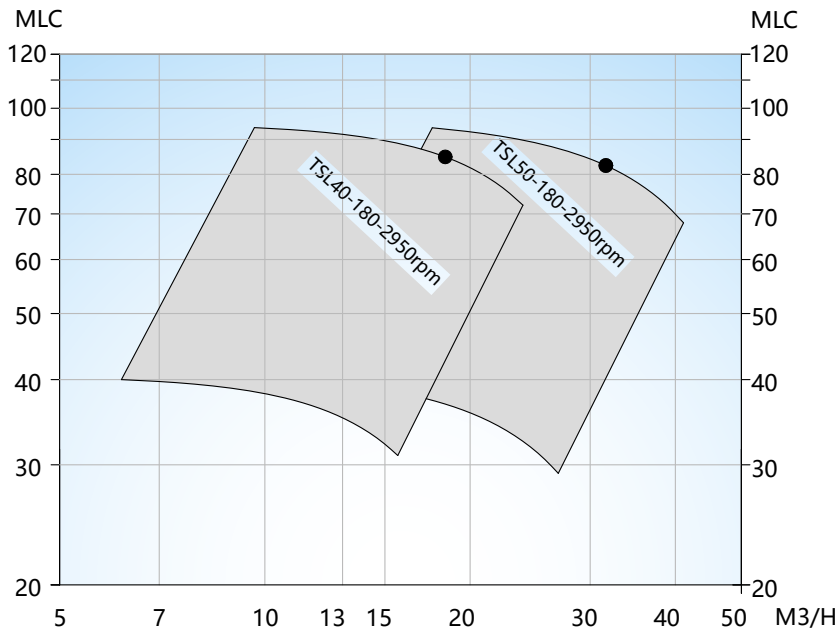

Capacity: 1 m³/H = 4.4 USGPM TOTAL HEAD: 1 M = 3.28 FEET • MAX EFFICIENCY

TSL Centrifugal Pump, 60 HZ

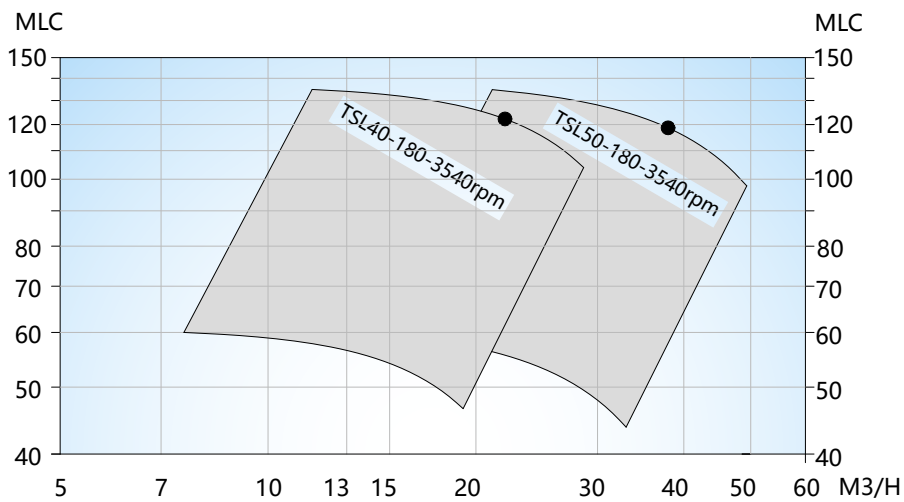

Capacity: 1 m³/H = 4.4 USGPM TOTAL HEAD: 1 M = 3.28 FEET • MAX EFFICIENCY

ROTAN® - Internal Gear Pumps for Marine

All the ROTAN® models have a differential pressure up to 16 bar/232 psi and a suction lift up to 0.8 bar/11.6 psi vacuum while pumping.

ROTAN® GP

ROTAN® GP - General Purpose	
Capacity range	Up to 50 m ³ /h / 220 gpm
Speed	Up to 1750 rpm
Differential pressure	Up to 16 bar / 232 psi
Suction lift	Up to 0.5 / 7.25 psi bar vacuum while priming Up to 0.8 bar / 11.6 psi vacuum while pumping
Viscosity range	Up to 7,500 cSt
Temperature	Up to 150°C / 302°F
Pump medium	For clean, non abrasive liquids and clean oil. Fuel, diesel, gas, and lube oil.

ROTAN® GP

General purpose pumps in cast iron. The simple and compact construction makes it a competitive pump suitable for most applications.

GP pump benefits:

- Easy installation
- Low maintenance costs
- Small footprint
- Low noise and vibration

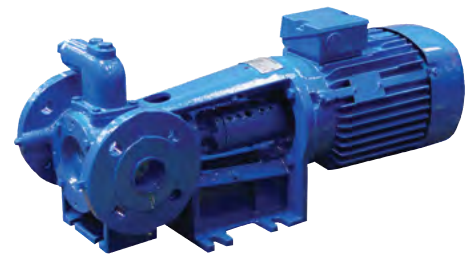

ROTAN® GP

ROTAN® HD

ROTAN® GP - Heavy Duty	
Capacity range	Up to 250 m ³ /h / 1100 gpm
Speed	Up to 1750 rpm
Differential Pressure	Up to 16 bar / 232 psi
Suction lift	Up to 0.5 bar / 7.25 psi vacuum while priming Up to 0.8 bar / 11.6 psi vacuum while pumping
Viscosity range	Up to 250,000 cSt
Temperature	Up to 250°C / 482°F
Pump medium	For viscous, non-corrosive liquids. Fuel, diesel, gas and lube oil.

ROTAN® HD

Heavy duty pumps in cast iron for a wide range of viscous, non-corrosive liquids. Designed for difficult applications and those involving high-viscosity oils.

HD pump benefits:

- Heavy duty
- High reliability
- Low maintenance costs
- Low noise and vibration



ROTAN® HD

ROTAN® ED

ROTAN® ED - Environmental Duty	
Capacity range	Up to 90 m ³ /h / 396 gpm
Speed	Up to 1750 rpm
Differential pressure	Up to 16 bar / 232 psi
Suction lift	Up to 0.5 bar / 7.25 psi vacuum while priming Up to 0.8 bar / 11.6 psi vacuum while pumping
Viscosity range	Up to 10,000 cSt
Temperature	Up to 250°C / 482°F
Pump medium	Where no leakage, liquid or gaseous, is allowed. Fuel, diesel, gas, and lube oil.

ROTAN® ED

Environmental duty - Magnetically coupled pumps in cast iron, carbon or stainless steel for ultimate protection against leakage.

ED pump benefits:

- Magnetically coupled pumps for ultimate protection against leakage.
- Easy reversible direction of flow.



ROTAN® ED

The art of transporting water is finding the right solution, with maximum efficiency, for each situation. The DPV series of vertical, multistage, centrifugal pumps is the result of 55 years of experience and the pumps can be used for numerous applications.

The new DPV pump series is revolutionary in terms of energy-savings and efficiency. Corrosion-free materials, advanced production methods and an optimised hydraulic assembly all contribute towards providing a unique example of craftsmanship.

The modular construction of the product enables you to modify the pump according to your specifications.



Modular construction
Quality materials

50 Hz					
Model	DPV 2	DPV 4	DPV 6	DPV 10 2P	DPV 10 4P
Capacity					
Capacity range (m ³ /h)	0.2-3.3/0.9-15	0.4-6.5/1.8-29	0.6-9/2.6-40	1.0-13.2/4-58	0.5-6.6/2-29
Nominal capacity at Qopt. (m ³ /h)/(gpm)	1.9/8.4	4/18	6.3/28	10/44	5/22
Pressure					
Norm pressure	PN16-25-40				
Maximum pump pressure (m)/(ft)	229/751	234/768	256/840	239/784	58/190
Maximum pressure at Qopt. (m)/(ft)	187/614	193/633	200/654	179/587	43/141
NPSH at Qopt. (m)/(ft)	2.2/7.2	1.2/4	1.2/4	1.2/4	0.9/3
Hydraulic assembly					
Temperature range medium	-20 - +140° C / -4 - 284° F				

DP pump application

- ME pre-heating pump
- Hot water circulation pump
- Refrigeration water circulation pump
- HVAC water circulation pump
- Technical water pump
- Hydrophore pump
- Boiler water transfer pump
- Chemical clean pump

50 Hz					
Model	DPV 15 2P	DPV 15 4P	DPV 25 2P	DPV 25 4P	DPV 85
Capacity					
Capacity range (m ³ /h)/(gpm)	1.8-22.5/8-99	0.98-11.3/4.3-50	2.8-35/12-154	1.4 - 17.5	8.5 - 112.8
Nominal capacity at Qopt. (m ³ /h)/(gpm)	18/79	9.8/43	28/123	14	85.7
Pressure					
Norm pressure	PN16-25-40				
Maximum pump pressure (m)/(ft)	248/814	59/194	246/807		176/577
Maximum pressure at Qopt. (m)/(ft)	193/633	44/144	185/607	45/148	132/433
NPSH at Qopt. (m)/(ft)	1.2/4	0.6/2	3.0/10	0.8/3	2.2/7
Hydraulic assembly					
Temperature range medium	-20 up to + 140° C / -4 - 284° F				

Low NPSH

- Extended life span as a result of favourable suction conditions
- NPSH-level 0.6 up to 3.8 (Qopt)

Modular construction

- Wide range of options
- All specials are standard
- Short delivery times

60 Hz					
Model	DPV 2	DPV 4	DPV 6	DPV 10 2P	DPV 10 4P
Capacity					
Capacity range (m ³ /h)/(gpm)	0.24-4/1-18	0.48 - 7.8	0.72 - 10.8	1.3 -15.8	0.6 - 7.9
Nominal capacity at Qopt. (m ³ /h)/(gpm)	2.3/10	4.8	7.6	13.3	6.3
Pressure					
Norm pressure	PN16-25-40				
Maximum pump pressure (m)/(gpm)	246/807	238/781	255/837	246/807	61/200
Maximum pressure at Qopt. (m)/(gpm)	201/659	195/640	199/653	173/568	44/144
NPSH at Qopt. (m)/(ft)	3/10	1.8/6	2/7	2/7	1.3/4
Hydraulic assembly					
Temperature range medium	-20 - +140° C / -4 - 284° F				

60 Hz					
Model	DPV 15 2P	DPV 15 4P	DPV 25 2P	DPV 25 4P	DPV 85
Capacity					
Capacity range (m ³ /h)/(gpm)	2.2-27/10-119	1.1-13.8/5-41	3.4-42/15-185	1.3 -15.8	10-132/44-551
Nominal capacity at Qopt. (m ³ /h)/(gpm)	21.7/96	10.9/48	34/150	34/150	100/440
Pressure					
Norm pressure	PN16-25-40				
Maximum pump pressure (m)/(ft)	233/764	57/187	210/689	87/285	151/495
Maximum pressure at Qopt. (m)/(ft)	177/551	43/141	157/515	65/213	108/354
NPSH at Qopt. (m)/(ft)	1.5/6	1.3/4	4.6/15	1.1/3.6	3.8/12
Hydraulic assembly					
Temperature range medium	-20 up to + 140° C / -4 - 284° F				

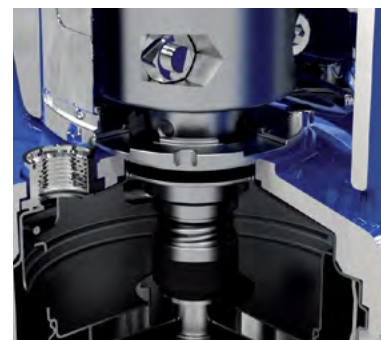

Wide range of shaft seals.
Replace without dismantling the pump.

DESMI DESERVE

After Sales & Service

We always strive to provide our customers with the very best service! That's why we have established DESMI DeServe - your guarantee for an excellent service 24/7/365.

Our Spare Parts Kits cover more pumps and have all the necessary parts when overhauling your pumps, but we also have individual spare parts that match your immediate need for maintenance.

Our DESMI 48 is for you, who needs a replacement pump immediately. The DESMI 48 makes sure you can have your pumps replaced and ready for shipping within 48 hours.

Our service on all pumps and solutions includes:

- Installation
- Commissioning
- On-site Service
- Repair / Maintenance

Don't hesitate to contact us right away if you need our assistance.

Our dedicated global DESMI Service Team delivering local service





DESMI Genuine Spare Parts Kits for Simple Overhaul and Service

DESMI provides spare parts kits for easy and simple maintenance and overhaul of your pumps. We offer a variety of spare parts kits for a number of DESMI pump series.

To determine which spare parts kit you need and to provide you with the best service, we need to have the following information:

- Pump type (e.g. NSL 150-265)
- Serial number (e.g. 323249 or 30192-1)

Spare Parts Kits include:

- Mechanical shaft seal
- Special tool
- Bearings
- O-rings
- Gaskets
- Washers & nuts
- Item list
- Etc.



The DESMI Service Team operates globally and around the clock. We can offer simple advice over the phone or full, on-site maintenance and service programmes.

The team is factory-trained and fully capable of meeting both your technical and practical demands. We have customized programmes to meet specific client requirements and be your partner of choice.

DESMI Service Team supports a working culture based on an appropriate respect for health, safety and environmental issues.

In case of emergency breakdowns, we are always able to access our global parts database, sending spare parts or complete pumps 24/7/365.



In need of more information or specifications? Contact us at desmi@desmi.com or read more about DESMI and DESMI's other products and solutions at www.desmi.com

MARINE & OFFSHORE

INDUSTRY

ENVIRO-CLEAN

DEFENCE & FUEL

UTILITY

www.desmi.com

DESMI